

2024

**RETAIL PRICE LIST
AND COMPLETE
APPLICATION LIST**

**VALID FROM
1ST OF JANUARY
2024**

**EURO PRICES VAT
EXCLUDED**



N: NEW
NV: VARIATION

NOTE:

valid for the tables showing the model of the car:
for all the vehicles models where isn't expressly indicated
the year of the production-end: it's intended that the application
is valid until the discontinued-product date.

Download the 2024 applications list in pdf from
www.ompracing.com or scanning the QR code



REF.	Euro	REF.	Euro	REF.	Euro	REF.	Euro	REF.	Euro	
61	ZN AMPLIFIERS / CENTRALINE ZN		6300011	Z 179,00	AA0-0108	C 78,00	AA0-104P-6	C 868,00	AB0-0100-275A	C 1.436,00
6100002	Z 183,00	6300012	Z 179,00	AA0-0109	C 120,00	AA0-104P-60	C 868,00	AB0-0100-275RS	C 1.091,00	
6100003	Z 183,00	6300013	Z 199,00	AA0-0110-A01	C 85,00	AA0-104P-7	C 868,00	AB0-0100-276	C 1.675,00	
6100004	Z 183,00	6300014	Z 199,00	AA0-0110-B01	C 130,00	AA0-104P-70	C 868,00	AB0-0100-28	C 868,00	
6100008	Z 428,00	6300015	Z 83,00	AA0-0111-A01	C 279,00	AA0-104P-76	C 868,00	AB0-0100-2S	C 1.488,00	
6100009	Z 428,00	6300016	Z 179,00	AA0-0111-B01	C 229,00	AA0-104P-8	C 868,00	AB0-0100-333	C 1.498,00	
6100010	Z 428,00	6300017	Z 179,00	AA0-0111-C01	C 277,00	AA0-104P-80	C 868,00	AB0-0100-334	C 1.533,00	
6100013	Z 28,00	6300018	Z 199,00	AA0-0113-A01	C 58,00	AA0-104P-86	C 868,00	AB0-0100-337	C 1.946,00	
6100014	Z 56,00	6300019	Z 32,00	AA0-0113-B01	C 38,00	AA0-104P-9	C 868,00	AB0-0100-337A	C 2.008,00	
6100018	Z 22,00	6300023	Z 83,00	AA0-0113-C01	C 26,00	AA0-104P-91	C 868,00	AB0-0100-338	C 1.387,00	
6100019	Z 28,00	6300024	Z 179,00	AA0-0113-D01	C 36,00	AA0-104P-93	C 868,00	AB0-0100-338A	C 1.318,00	
6100024	Z 597,00	6300025	Z 179,00	AA0-0115	C 25,00	AA0-104P-94	C 868,00	AB0-0100-339	C 1.520,00	
6100026	Z 510,00	6300026	Z 131,00	AA0-0116	C 25,00	AA0-104P-95	C 868,00	AB0-0100-340A	C 1.916,00	
6100027	Z 510,00	6300027	Z 199,00	AA0-0122-A01	C 9,90	AA0-104P-96	C 868,00	AB0-0100-341	C 1.399,00	
6100028	Z 510,00	6300028	Z 220,00	AA0-0122-B01	C 9,50	AA0-104P-97	C 868,00	AB0-0100-342	C 1.521,00	
6100029	Z 84,00	6300029	Z 220,00	AA0-0123	C 10,30	AB ROLL BARS		AB0-0100-343	C 1.874,00	
6100030	Z 28,00	6300030	Z 158,00	AA0-0175-A01	C 12,70	AB0-0100-131	C 868,00	AB0-0100-345	C 2.162,00	
6100031	Z 158,00	6300031	Z 220,00	AA0-0175-B01	C 136,00	AB0-0100-131S	C 1.376,00	AB0-0100-347	C 1.502,00	
6100032	Z 522,00	6300032	Z 220,00	AA0-0175-C01	C 6,00	AB0-0100-131SK	C 1.544,00	AB0-0100-348	C 1.726,00	
6100033	Z 312,00	6300033	Z 158,00	AA0-0195	C 19,00	AB0-0100-17	C 868,00	AB0-0100-349	C 2.275,00	
6100034	Z 522,00	6300034	Z 79,00	AA0-0200	C 16,00	AB0-0100-2	C 877,00	AB0-0100-349T	C 2.414,00	
6100035	Z 28,00	6300035	Z 79,00	AA0-0201	C 16,00	AB0-0100-228H	C 1.204,00	AB0-0100-354	C 1.206,00	
6100036	Z 1.150,00	N 6300036	Z 199,00	AA0-0202	C 145,00	AB0-0100-228H	C 1.204,00	AB0-0100-354A	C 1.304,00	
6100037	Z 380,00	64	ZN ACCESSORIES / ACCESSORI ZN		AA0-0203	C 26,00	AB0-0100-234	C 1.048,00	AB0-0100-355	C 1.423,00
N 6100038	Z 285,00	6400001	Z 51,00	AA0-0204	C 124,00	AB0-0100-237A	C 1.413,00	AB0-0100-357	C 1.775,00	
N 6100039	Z 285,00	6400002	Z 51,00	AA0-104P-1	C 863,00	AB0-0100-238A	C 1.436,00	AB0-0100-358	C 1.573,00	
N 6100040	Z 285,00	6400003	Z 51,00	AA0-104P-10	C 942,00	AB0-0100-240A	C 1.816,00	AB0-0100-359	C 2.328,00	
N 6100041	Z 800,00	6400004	Z 70,00	AA0-104P-139	C 868,00	AB0-0100-243	C 1.660,00	AB0-0100-360	C 1.862,00	
N 6100042	Z 370,00	6400005	Z 70,00	AA0-104P-142	C 868,00	AB0-0100-246	C 1.058,00	AB0-0105-126A	C 876,00	
62	ZN HEADSET / HEADSET ZN		6400006	Z 70,00	AA0-104P-145	C 868,00	AB0-0100-246RS	C 1.117,00	AB0-0105-128A	C 907,00
6200001	Z 140,00	6400007	Z 70,00	AA0-104P-146	C 868,00	AB0-0100-248	C 1.250,00	AB0-0105-130A	C 906,00	
6200002	Z 190,00	6400008	Z 70,00	AA0-104P-147	C 868,00	AB0-0100-250	C 1.424,00	AB0-0105-136A	C 907,00	
6200003	Z 190,00	6400009	Z 70,00	AA0-104P-151	C 868,00	AB0-0100-250A	C 1.313,00	AB0-0105-138A	C 907,00	
6200004	Z 190,00	6400010	Z 81,00	AA0-104P-152	C 868,00	AB0-0100-251AH	C 1.634,00	AB0-0105-144A	C 875,00	
6200005	Z 269,00	6400011	Z 81,00	AA0-104P-153	C 868,00	AB0-0100-253	C 1.312,00	AB0-0105-144T	C 871,00	
6200006	Z 269,00	6400012	Z 81,00	AA0-104P-154	C 868,00	AB0-0100-255	C 1.899,00	AB0-0105-180S	C 798,00	
6200007	Z 350,00	6400013	Z 81,00	AA0-104P-155	C 868,00	AB0-0100-255A	C 1.454,00	AB0-0105-182A	C 906,00	
N 6200009	Z 385,00	6400014	Z 81,00	AA0-104P-16	C 868,00	AB0-0100-257A	C 2.220,00	AB0-0105-202SH	C 1.388,00	
N 6200010	Z 85,00	6400015	Z 26,00	AA0-104P-22	C 868,00	AB0-0100-258A	C 2.289,00	AB0-0105-203AH	C 1.170,00	
63	ZN RADIO KIT / KIT RADIO ZN		6400016	Z 37,00	AA0-104P-29	C 868,00	AB0-0100-260A	C 1.433,00	AB0-0105-208S	C 1.124,00
6300001	Z 199,00	6400017	Z 42,00	AA0-104P-3	C 868,00	AB0-0100-261A	C 1.515,00	AB0-0105-213AS	C 1.043,00	
6300002	Z 79,00	6400018	Z 89,00	AA0-104P-30	C 868,00	AB0-0100-266	C 1.643,00	AB0-0105-217AH	C 950,00	
6300003	Z 199,00	6400019	Z 6,00	AA0-104P-32	C 868,00	AB0-0100-267	C 1.527,00	AB0-0105-218AH	C 1.122,00	
6300004	Z 199,00	6400021	Z 99,00	AA0-104P-34	C 868,00	AB0-0100-268	C 1.914,00	AB0-0105-218ASH	C 1.220,00	
6300005	Z 83,00	6400022	Z 99,00	AA0-104P-35	C 863,00	AB0-0100-269A	C 1.929,00	AB0-0105-220AH	C 1.059,00	
6300006	Z 199,00	6400023	Z 99,00	AA0-104P-36	C 868,00	AB0-0100-270A	C 2.003,00	AB0-0105-222A	C 922,00	
6300007	Z 83,00	N 6400024	Z 5,00	AA0-104P-4	C 868,00	AB0-0100-271	C 1.838,00	AB0-0105-50AS	C 2.008,00	
6300008	Z 35,00	AA ROLL BARS		AA0-104P-43	C 868,00	AB0-0100-271A	C 1.750,00	AB0-0105-68A	C 1.063,00	
6300009	Z 199,00	AA0-0102	C 495,00	AA0-104P-46	C 868,00	AB0-0100-273	C 1.158,00	AB0-0105-74S	C 1.310,00	
6300010	Z 83,00	AA0-0103	C 394,00	AA0-104P-47	C 868,00	AB0-0100-274	C 889,00	AB0-0106-126	C 1.535,00	
		AA0-0104-8S	C 1.250,00	AA0-104P-48	C 868,00	AB0-0100-274K	C 1.537,00	AB0-0106-128A	C 990,00	
				AA0-104P-5	C 868,00	AB0-0100-275	C 1.424,00	AB0-0106-128B	C 1.642,00	

REF.	Euro	REF.	Euro	REF.	Euro	REF.	Euro	REF.	Euro
AB0-0106-129AE	C 972,00	AB0-0106-96	C 1.894,00	AB0-105P-323	C 870,00	CD0-0395-A01	C 6,70	CR0-4201	C 116,00
AB0-0106-129AEW	C 648,00	AB0-0106-98A	C 1.866,00	AB0-105P-326	C 867,00	CD0-0395-A02	C 6,00	CR0-4202	C 54,00
AB0-0106-129B	C 1.623,00	AB0-0106-98B	C 1.851,00	AB0-105P-328	C 916,00	CD0-0398	C 120,00	CR0-4203	C 107,00
AB0-0106-12A	C 2.160,00	AB0-0107	C 446,00	AB0-105P-329	C 965,00	CD0-0399	C 6,70	CR0-4300	C 98,00
AB0-0106-130A	C 1.867,00	AB0-0108	C 497,00	AB0-105P-330	C 965,00	CD0-0400-B01	C 30,00	CR0-4301	C 116,00
AB0-0106-136A	C 1.910,00	AB0-105P-125	C 907,00	AB0-105P-332	C 830,00	CD0-0401-B01	C 30,00	CR0-4302	C 119,00
AB0-0106-138A	C 1.398,00	AB0-105P-126	C 786,00	AB0-105P-340	C 786,00	CD0-0404	C 22,50	CR0-4303	C 119,00
AB0-0106-138AW	C 1.124,00	AB0-105P-128	C 786,00	AB0-105P-45	C 786,00	CD0-0405	C 29,50	CR0-4304	C 133,00
AB0-0106-144A	C 1.729,00	AB0-105P-13	C 786,00	AB0-105P-49	C 786,00	CD0-0407	C 10,20	CR0-4305	C 125,00
AB0-0106-144AW	C 1.118,00	AB0-105P-130	C 786,00	AB0-105P-50	C 867,00	CD0-0408	C 64,00	CR0-4306	C 129,00
AB0-0106-154A	C 1.729,00	AB0-105P-136	C 786,00	AB0-105P-50RS	C 1.091,00	CD0-0409	C 26,00	CR0-4307	C 156,00
AB0-0106-154B	C 1.929,00	AB0-105P-138	C 786,00	AB0-105P-51	C 786,00	CD0-0410	C 96,00	CR0-4308	C 156,00
AB0-0106-156A	C 1.947,00	AB0-105P-144	C 786,00	AB0-105P-56	C 786,00	CD0-0411	C 96,00	CR0-4309	C 158,00
AB0-0106-157A	C 2.120,00	AB0-105P-144RS	C 1.091,00	AB0-105P-57	C 786,00	CD0-0412	C 9,90	CR0-4400	C 142,00
AB0-0106-17A	C 1.883,00	AB0-105P-156	C 786,00	AB0-105P-67	C 786,00	CD0-0414	C 16,00	CR0-4401	C 143,00
AB0-0106-17AW	C 1.618,00	AB0-105P-165	C 786,00	AB0-105P-74	C 786,00	CD0-0415	C 11,30	CR0-4402	C 155,00
AB0-0106-17B	C 1.936,00	AB0-105P-173	C 786,00	AB0-105P-81	C 786,00	CD0-0416	C 11,30	CR0-4403	C 141,00
AB0-0106-182A	C 1.536,00	AB0-105P-180	C 786,00	AB0-105P-98	C 786,00	CD0-0417	C 49,50	CR0-4404	C 143,00
AB0-0106-182AW	C 1.441,00	AB0-105P-182	C 786,00	AB0-105P-99	C 786,00	CD0-0418	C 49,50	CR0-4405	C 163,00
AB0-0106-18A	C 2.066,00	AB0-105P-182RS	C 1.091,00	AR		CE EXTINGUISHERS / ESTINTORI		CR0-4406	C 163,00
AB0-0106-19A	C 1.714,00	AB0-105P-200	C 786,00	AR0-0100	C 372,00	CE0-FAL2-A01	C 564,00	CR0-4500	C 182,00
AB0-0106-203A	C 1.616,00	AB0-105P-202H	C 1.232,00	AR0-0101	C 847,00	CE0-FAL2-AB1	C 530,00	CR0-4501	C 253,00
AB0-0106-208A	C 1.505,00	AB0-105P-204	C 786,00	AR0-0204	C 802,00	CE0-FAL3-A01	C 684,00	CR0-4502	C 186,00
AB0-0106-209A	C 1.995,00	AB0-105P-206	C 786,00	AR0-0701	C 902,00	CE0-FAL3-AB1	C 635,00	CR0-4503	C 196,00
AB0-0106-211A	C 1.965,00	AB0-105P-207	C 786,00	AR0-0901	C 901,00	CE0-FAL4-A01	C	CR0-4504	C 225,00
AB0-0106-214	C 1.115,00	AB0-105P-209H	C 1.016,00	CA EXTINGUISHERS / ESTINTORI		CE0-SAL2-A01	C 629,00	CR0-4505	C 204,00
AB0-0106-217A	C 1.812,00	AB0-105P-21	C 786,00	CA0-0372-A01	C 245,00	CE0-SAL2-AB1	C 593,00	CR0-4600	C 230,00
AB0-0106-217AW	C 1.490,00	AB0-105P-210H	C 1.204,00	CA0-0372-AB1	C 184,00	CE0-SAL3-A01	C 769,00	CR0-4601	C 235,00
AB0-0106-219A	C 1.419,00	AB0-105P-212	C 786,00	CB HAND HELD EXTING. / ESTINTORI BRANDEGG.		CE0-SAL3-AB1	C 707,00	CR0-4602	C 234,00
AB0-0106-220A	C 1.669,00	AB0-105P-214	C 786,00	CB0-0316-A01	C 79,00	CE0-SAL3-B01	C 699,00	CR0-4603	C 253,00
AB0-0106-223A	C 1.999,00	AB0-105P-215	C 786,00	CB0-0319-A01	C 119,00	CE0-SAL3-BB1	C 636,00	CR0-4604	C 235,00
AB0-0106-228A	C 1.866,00	AB0-105P-220H	C 1.206,00	CB0-0322-A01	C 99,00	CE0-SAL4-A01	C 2.550,00	CR0-4605	C 244,00
AB0-0106-229A	C 2.291,00	AB0-105P-220HRS	C 1.091,00	CB0-0323-A01	C 339,00	CE0-SAL4-AB1	C 2.527,00	CR0-4606	C 267,00
AB0-0106-231A	C 2.785,00	AB0-105P-223	C 867,00	CB0-0323-A01	C 339,00	CE0-SAL4-B01	C 2.550,00	CR0-4607	C 281,00
AB0-0106-232A	C 2.120,00	AB0-105P-224	C 867,00	CB0-0351-A01	C 215,00	CE0-SAL4-BB2	C 2.399,00	CR0-4608	C 276,00
AB0-0106-233A	C 2.010,00	AB0-105P-225	C 786,00	CD EXT. REPLACEMENTS / RICAMBI ESTINTORI		CE0-SAL4-C01	C 2.550,00	CR0-4700	C 260,00
AB0-0106-233AW	C 1.831,00	AB0-105P-226	C 786,00	CD0-0300-A01	C 16,00	CE0-SAL4-CB1	C 2.399,00	CR0-4701	C 267,00
AB0-0106-235A	C 2.068,00	AB0-105P-227H	C 1.030,00	CD0-0309	C 25,00	CE0-SAL5-A01	C 1.550,00	CR0-4702	C 274,00
AB0-0106-235AW	C 1.725,00	AB0-105P-23	C 786,00	CD0-0311-A01	C 17,50	CE0-SAL5-AB1	C 1.474,00	CR0-4703	C 300,00
AB0-0106-236A	C 1.998,00	AB0-105P-24	C 786,00	CD0-0312	C 26,50	CE0-SAL5-B01	C 1.550,00	CR0-4704	C 308,00
AB0-0106-243A	C 2.258,00	AB0-105P-259H	C 1.183,00	CD0-0323-A01	C 9,30	CE0-SAL5-BB1	C 1.388,00	CR0-4705	C 308,00
AB0-0106-24A	C 2.015,00	AB0-105P-264	C 931,00	CD0-0323-B01	C 49,50	CE0-SAL5-C01	C 1.665,00	CR0-4706	C 318,00
AB0-0106-251A	C 2.502,00	AB0-105P-265	C 848,00	CD0-0323-B02	C 60,00	CE0-SAL5-CB1	C 1.530,00	CR0-4800	C 405,00
AB0-0106-252A	C 2.098,00	AB0-105P-272	C 907,00	CD0-0324-A01	C 15,00	CE0-SAL5-D01	C 1.665,00	CR0-4801	C 247,00
AB0-0106-252AW	C 1.831,00	AB0-105P-289	C 874,00	CD0-0324-A02	C 16,00	CE0-SAL5-DB1	C 1.480,00	CR0-4802	C 121,00
AB0-0106-253A	C 2.281,00	AB0-105P-291	C 786,00	CD0-0324-A03	C 16,00	N CE0-SAL5-E01	C 3.300,00	CR0-4803	C 299,00
AB0-0106-256A	C 2.154,00	AB0-105P-292	C 916,00	CD0-0335	C 23,00	CE0-SST1-A01	C 525,00	CR0-4804	C 253,00
AB0-0106-260A	C 2.725,00	AB0-105P-301	C 916,00	CD0-0356	C 25,50	CE0-SST1-AB1	C 490,00	CR0-4805	C 402,00
AB0-0106-261A	C 2.881,00	AB0-105P-304	C 786,00	CD0-0360	C 256,00	CM EXTINGUISHERS / ESTINTORI		CR0-4806	C 247,00
AB0-0106-261AW	C 2.261,00	AB0-105P-305	C 840,00	N CD0-0380-A01	C	CM0-FST1-A01	C 285,00	CR0-4807	C 116,00
AB0-0106-262A	C 3.029,00	AB0-105P-306	C 786,00	N CD0-0380-A02	C	CM0-FST1-AB1	C 246,00	CR0-4808	C 303,00
AB0-0106-262AW	C 2.391,00	AB0-105P-307	C 786,00	CD0-0390-A01	C 10,30	CM0-SST1-A01	C 299,00	CR0-4809	C 247,00
AB0-0106-263A	C 2.623,00	AB0-105P-308	C 786,00	CD0-0390-B01	C 10,30	CM0-SST1-AB1	C 256,00	CR0-4810	C 406,00
AB0-0106-275A	C 2.683,00	AB0-105P-309	C 786,00	CD0-0391-A01	C 9,30	CR MAINTENANCE EXTING. / MANUTENZIONE ESTINT.		CR0-4910	C 203,00
AB0-0106-45A	C 1.419,00	AB0-105P-311	C 786,00	CD0-0391-A02	C 9,30	CR0-4100	C 56,00	CR0-4911	C 56,00
AB0-0106-49A	C 1.615,00	AB0-105P-313	C 786,00	CD0-0391-A03	C 6,20	CR0-4101	C 85,00	CR0-5000	C 1.131,00
AB0-0106-49B	C 1.939,00	AB0-105P-313RS	C 1.091,00	CD0-0392-A01	C 7,80	CR0-4102	C 56,00	CR0-5001	C 642,00
AB0-0106-65	C 2.039,00	AB0-105P-314	C 786,00	CD0-0392-A02	C 10,30	CR0-4103	C 85,00	CR0-6000	C 1.260,00
AB0-0106-664A	C 2.340,00	AB0-105P-316	C 980,00	CD0-0392-A03	C 7,60	CR0-4104	C 102,00	CR0-6001	C 642,00
AB0-0106-68A	C 2.266,00	AB0-105P-317	C 786,00	CD0-0393-A01	C 9,30	CR0-4105	C 82,00	CR0-7000	C 600,00
AB0-0106-68B	C 2.348,00	AB0-105P-318	C 786,00	CD0-0393-A02	C 9,10	CR0-4106	C 102,00	CR0-7001	C 305,00
AB0-0106-77A	C 1.658,00	AB0-105P-319	C 786,00	CD0-0394	C 6,70	CR0-4200	C 67,00	CR0-7002	C 668,00
AB0-0106-86A	C 1.618,00	AB0-105P-320	C 786,00					CR0-7003	C 305,00
AB0-0106-86B	C 1.630,00	AB0-105P-322	C 830,00					CR0-8000	C 645,00

REF.	Euro	REF.	Euro	REF.	Euro	REF.	Euro	REF.	Euro	
CR0-8001	C 305,00	ER E-RACING COCKPITS		HB0-0699	C 47,00	HD0-0773	A 84,00	HD0-0846-L	A 146,00	
CR0-8002	C 759,00			HB0-0700	C 47,00	HD0-0776	A 73,00	HD0-0846-R	A 146,00	
CR0-8003	C 305,00		N ER0-0001	D 1.105,00	HB0-0701	C 123,00	HD0-0777	A 115,00	HD0-0847-L	A 159,00
DA SAFETY BELTS / CINTURE DI SICUREZZA		N ER0-0002	D 900,00	HB0-0702	C 67,00	HD0-0778-L	A 104,00	HD0-0847-R	A 159,00	
		N ER0-0003	D 983,00	HB0-0703	C 120,00	HD0-0778-R	A 104,00	HD0-0848	A 115,00	
	DA0-0102-A01	C 509,00	HA SEATS / SEDILI	N HB0-0707	P 25,00	HD0-0779-L	A 115,00	HD0-0850	A 153,00	
DA0-0102-A02	C 509,00	HA0-0737-B01		A 315,00	N HB0-0708	P 12,00	HD0-0779-R	A 115,00	HD0-0851-L	A 142,00
DA0-0102-A03	C 509,00	HA0-0741-B01		C 227,00	N HB0-0709	P 13,00	HD0-0780-L	A 115,00	HD0-0851-R	A 142,00
DA0-0102-A04	C 509,00	HA0-0745-A01	C 2.350,00	HC SEAT BRACKETS / STAFFE SEDILI		HD0-0780-R	A 115,00	HD0-0852-L	A 183,00	
DA0-0102-A05	C 509,00	HA0-0756-A01	A 299,00		HC0-0660	C 76,00	HD0-0781-L	A 115,00	HD0-0852-R	A 183,00
DA0-0104-A01	C 509,00	HA0-0757-A01	A 355,00		HC0-0663	A 130,00	HD0-0781-R	A 115,00	HD0-0853	A 153,00
DA0-0202-A01	C 323,00	HA0-0760-B01	C 285,00	HC0-0664	A 15,00	HD0-0782	A 115,00	HD0-0855	A 205,00	
DA0-0202-A02	C 323,00	HA0-0762-B01	C 479,00	HC0-0665	A 52,00	HD0-0783-L	A 174,00	HD0-0859-L	A 146,00	
N DA0-0202-A05	C 359,00	HA0-0766-B01	C 359,00	HC0-0729	A 80,00	HD0-0783-R	A 174,00	HD0-0859-R	A 146,00	
DA0-0203-A01	C 255,00	HA0-0768-B01	C 2.350,00	HC0-0731-B01	C 76,00	HD0-0784-L	A 121,00	HD0-0862-L	A 146,00	
DA0-0203-A02	C 255,00	HA0-0771-B01	C 650,00	HC0-0733-B01	C 58,00	HD0-0784-R	A 121,00	HD0-0862-R	A 146,00	
DA0-0204-B01	C 207,00	HA0-0772-B01	C 570,00	HC0-0830	C 325,00	HD0-0785-L	A 115,00	HD0-0863-L	A 125,00	
DA0-0204-B02	C 197,00	HA0-0772-B02	C 850,00	HC0-0857	A 109,00	HD0-0785-R	A 115,00	HD0-0863-R	A 125,00	
DA0-0205-A01	C 319,00	HA0-0773-B01	C 510,00	HC0-0858	A 165,00	HD0-0786-L	A 163,00	HD0-0864-L	A 125,00	
DA0-0205-A02	C 319,00	HA0-0773-B02	C 810,00	HC0-0860	A 146,00	HD0-0786-R	A 163,00	HD0-0864-R	A 125,00	
DA0-0206-A01	C 265,00	HA0-0774-B01	C 499,00	HC0-0872	C 13,00	HD0-0792-L	A 121,00	HD0-0865-L	A 167,00	
DA0-0206-A02	C 265,00	HA0-0778-B01	C 599,00	HC0-0880-A01	D 274,00	HD0-0792-R	A 121,00	HD0-0865-R	A 167,00	
DA0-0208-A01	C 187,00	HA0-0779-B01	C 2.950,00	HC0-0880-A02	D 274,00	HD0-0793-L	A 129,00	HD0-0866-L	A 136,00	
DA0-0210-A01	C 359,00	HA0-0780-B01	C 580,00	HC0-0893	C 215,00	HD0-0793-R	A 129,00	HD0-0866-R	A 136,00	
N DA0-0211-A02	C 419,00	HA0-0781-B01	C 265,00	HC0-0907	D 1.699,00	HD0-0795	A 139,00	HD0-0867-L	A 136,00	
DA0-0504-A01	A 109,00	HA0-0786-A01	C 3.600,00	HC0-0913-A01	C 260,00	HD0-0796	A 129,00	HD0-0867-R	A 136,00	
DA0-0505-A01	A 109,00	HA0-0788-A01	C 2.650,00	HC0-0913-A02	C 146,00	HD0-0797-L	A 121,00	HD0-0868	A 136,00	
DA0-0507-A01	A 119,00	HA0-0789-A01	D 6.600,00	HC0-0913-A03	C 31,50	HD0-0797-R	A 121,00	HD0-0869-L	A 129,00	
DA0-0508-A01	A 145,00	HA0-0790-A01	C 335,00	HC0-0913-A04	C 36,00	HD0-0798	A 129,00	HD0-0869-R	A 129,00	
DA0-0509-A01	A 115,00	HA0-0793-A01	C 640,00	HC0-0913-A05	C 62,00	HD0-0799-L	A 121,00	HD0-0870-L	A 119,00	
DA0-0801-B01	C 177,00	HA0-0794-A01	C 699,00	HC0-0914-A01	C 269,00	HD0-0799-R	A 121,00	HD0-0870-R	A 119,00	
DB BELT ACCESSORIES / ACCESSORI CINTURE		HA0-0798-A01	D 7.200,00	HC0-0914-A02	C 79,00	HD0-0803-L	A 129,00	HD0-0871-L	A 119,00	
	DB0-0418-A01	C 8,00	HA0-0800-A01	D 8.600,00	HC0-0914-A03	C 220,00	HD0-0803-R	A 129,00	HD0-0871-R	A 119,00
	DB0-0420-A01	C 4,50	HA0-0803-B01	C 255,00	HC0-0922	C 97,00	HD0-0804	A 121,00	HD0-0873	A 129,00
DB0-0421-A01	C 3,30	HA0-0805-A01	D 8.850,00	HC0-0923	C 106,00	HD0-0808	A 121,00	HD0-0875-L	A 129,00	
DB0-0450-A01	A 21,00	HA0-0807-A01	D 9.850,00	HC0-0924	C 136,00	HD0-0810-L	A 129,00	HD0-0875-R	A 129,00	
DB0-0450-A02	A 30,00	HA0-0815-A01	D 4.800,00	HC0-0925	C 152,00	HD0-0810-R	A 129,00	HD0-0876-L	A 154,00	
DB0-0455	A 60,00	HA0-0817-A01	D 3.100,00	HC0-0928	D 401,00	HD0-0813-L	A 129,00	HD0-0876-R	A 153,00	
DB0-0459	C 7,00	HA0-0818-A01	C 589,00	HC0-0929-A01	D 1.699,00	HD0-0813-R	A 129,00	HD0-0877-L	A 160,00	
DB0-0460-B01	C 23,00	HA0-0825-A01	D 6.100,00	HC0-0929-A02	D 1.699,00	HD0-0814-L	A 118,00	HD0-0877-R	A 160,00	
DB0-0461	C 11,20	HA0-0827-A01	D10.300,00	HC0-0930	C 25,00	HD0-0814-R	A 129,00	HD0-0879	C 109,00	
EA MASTER SWITCHES / STACCABATTERIA		N HA0-0829-A01	D	HC0-0931	C 25,00	HD0-0815-L	A 146,00	HD0-0885	A 129,00	
	EA0-0460	C 19,00	N HA0-0830-A01	C 499,00	HC0-0932	C 12,40	HD0-0815-R	A 146,00	HD0-0887	A 154,00
	EA0-0462	C 42,00	N HA0-0831-A01	C 1.590,00	HC0-0934	D 401,00	HD0-0816-L	A 136,00	HD0-0888-L	A 154,00
EA0-0463	C 8,50	N HA0-0831-A02	C 1.590,00	HC0-0935-A01	D 1.383,00	HD0-0816-R	A 136,00	HD0-0888-R	A 154,00	
EA0-0464	C 10,50	N HA0-0832-A01	C 690,00	HC0-0935-A02	D 1.383,00	HD0-0817	A 136,00	HD0-0889-L	A 171,00	
EA0-0467	C 16,50	N HA0-0833-A01	C	HC0-0945	D 139,00	HD0-0818	A 136,00	HD0-0889-R	A 171,00	
EB TOW HOOKS / GANCI TRAINO		N HA0-0834-A01	C	HC0-0951-A01	C 229,00	HD0-0819	A 136,00	HD0-0890-L	A 171,00	
	EB0-0480	C 38,00	N HA0-0835-A01	P 269,00	HC0-0951-A02	C 229,00	HD0-0821-L	A 146,00	HD0-0890-R	A 171,00
	EB0-0482	C 16,50	N HA0-0835-A02	L 439,00	HC0-0951-A03	C 229,00	HD0-0821-R	A 146,00	HD0-0891	A 153,00
EB0-0483	C 24,50	N HA0-0836-A01	P 299,00	N HC0-0951-A04	C 229,00	HD0-0825-L	A 129,00	HD0-0892	A 125,00	
EB0-0487	C 37,00	HA0-0900-A01	D 3.000,00	N HC0-0951-A05	C 229,00	HD0-0825-R	A 129,00	HD0-0903	A 125,00	
EB0-0489	C 33,50	HA0-0901-A01	C 1.390,00	HD SEAT BRACKETS ADAPT./ ADATT. STAFFE SEDILI	HD0-0828-L	A 104,00	HD0-0905	A 146,00		
EB0-0490	C 34,00	HA0-0902-A01	D 3.200,00		HD0-0828-R	A 104,00	HD0-0906	A 153,00		
EB0-0491	C 31,00	HA0-0903-A01	C 1.290,00		HD0-0834-L	A 129,00	HD0-0937	A 136,00		
EB0-0492	C 25,00	N HA0-0904-A01	C 1.440,00	HD0-0834-R	A 129,00	HD0-0938	A 136,00			
EB0-0570	A 33,00	N HA0-0905-A01	C 1.340,00	HD0-0835-L	A 129,00	HD0-0941-L	A 136,00			
HB SEAT CUSHIONS / CUSCINI SEDILI		HB0-0662	C 47,50	HD0-0835-R	A 129,00	HD0-0941-R	A 136,00			
	EB0-0571	A 23,50	HB0-0692	C 27,00	HD0-0838-L	A 129,00	IA RACING SUITS / TUTE RACING			
	EB0-0572	A 46,00	HB0-0693	C 48,50	HD0-0838-R	A 129,00		IA0-1816-C01	C 599,00	
EB0-0576	A 25,00	HB0-0695	C 50,00	HD0-0735	A 74,00	NVIA0-1828-E01		C 359,00		
EB0-0578	A 19,50	HB0-0698	C 57,00	HD0-0737-L	A 122,00	HD0-0740	A 94,00	IA0-1842-B01	C 1.039,00	
EB0-0580	A 28,00			HD0-0737-R	A 121,00	HD0-0742-L	A 121,00	NVIA0-1847-C01	C 299,00	
				HD0-0738	A 121,00	HD0-0742-R	A 121,00			
				HD0-0739	A 121,00	HD0-0772	A 121,00			

REF.	Euro	REF.	Euro	REF.	Euro	REF.	Euro	REF.	Euro
IA0-1854-B01	C 469,00	IE0-0791-A02	L 95,00	KK0-4001	C 50,50	MA0-1681	A 159,00	MA0-1819	A 164,00
IA0-1854-B02	C 449,00	IE0-0792-A01	C 149,00	KK0-4003	C 54,00	MA0-1683	A 117,00	MA0-1820	A 170,00
IA0-1857-B01	C 1.099,00	IE0-0792-A02	L 206,00	KK0-4005	C 20,00	MA0-1684	A 179,00	MA0-1821	A 179,00
IA0-1859-B01	C 810,00	IE0-0793-A01	C 125,00	KK0-4006	C 20,00	MA0-1685	A 159,00	MA0-1823	A 157,00
IA0-1860-A01	C 1.099,00	IE0-0793-A02	L 158,00	KK0-4009	C 45,00	MA0-1693	A 135,00	MA0-1825	A 271,00
IA0-1860-A02	L 1.097,00	IE0-0794-A01	C 67,00	KK0-5030-A01	C 69,00	MA0-1695	A 83,00	MA0-1826	A 153,00
IA0-1861-A01	C 1.279,00	IE0-0795-A01	C 134,00	KK0-5030-A02	C 75,00	MA0-1696	A 73,00	MA0-1828	A 85,00
IA0-1862-A01	C	IE0-0796-A01	C 104,00	KK0-5032	C 75,00	MA0-1698	A 145,00	MA0-1831	A 164,00
IA0-1864-A01	C 599,00	KA KARTING SUIT / TUTE KARTING		MA STRUT BRACES / BARRE DUOMI		MA0-1699	A 125,00	MA0-1833	A 149,00
N IA0-1869-A01	C	KA0-1719-A01	C 83,00	MA0-1529	A 129,00	MA0-1721	A 157,00	MA0-1835	A 161,00
N IA0-1901-B01	C 189,00	KA0-1719-AK1	C 78,00	MA0-1532	A 107,00	MA0-1722	A 135,00	MA0-1836	A 164,00
IB RACING GLOVES / GUANTI RACING		KA0-1726-B01	C 429,00	MA0-1533	A 117,00	MA0-1724	A 93,00	MA0-1838	A 105,00
IB0-0702-A01	C 67,00	KA0-1726-BK1	C 392,00	MA0-1534	A 119,00	MA0-1726	A 79,00	MA0-1839	A 163,00
IB0-0746-B01	C 123,00	KA0-1727-A01	C 179,00	MA0-1535	A 56,00	MA0-1729	A 93,00	MA0-1840	A 113,00
IB0-0747-A01	C 41,00	KA0-1727-AK1	C 169,00	MA0-1538	A 95,00	MA0-1730	A 161,00	MA0-1841	A 158,00
IB0-0747-A02	L 46,00	KA0-1728-A01	C 135,00	MA0-1542	A 71,00	MA0-1732	A 160,00	MA0-1845	A 175,00
IB0-0758-B01	C 146,00	KA0-1728-AK1	C 125,00	MA0-1553	A 133,00	MA0-1733	A 161,00	MA0-1846	A 144,00
IB0-0758-C01	C 146,00	KA0-1730-A01	C 205,00	MA0-1554	A 142,00	MA0-1738	A 121,00	MA0-1847	A 183,00
IB0-0763-B01	C	KA0-1730-AK1	C 195,00	MA0-1557	A 271,00	MA0-1739	A 133,00	MA0-1851	A 214,00
IB0-0770-A01	C 143,00	N KA0-1731-A01	C 435,00	MA0-1558	A 67,00	MA0-1740	A 125,00	MA0-1852	A 164,00
IB0-0772-A01	C 130,00	N KA0-1731-AK1	C 405,00	MA0-1559	A 151,00	MA0-1741	A 134,00	MA0-1855	A 85,00
NVIB0-0773-A01	C 199,00	KB KARTING GLOVES / GUANTI KARTING		MA0-1600	A 155,00	MA0-1742	A 231,00	MA0-1857	A 145,00
N IB0-0775-A01	C 176,00	KB0-2739-A01	C 43,00	MA0-1601	A 246,00	MA0-1743	A 138,00	MA0-1858	A 157,00
N IB0-0775-A02	L 222,00	KB0-2743-B01	C 47,00	MA0-1602	A 133,00	MA0-1745	A 231,00	MA0-1861	A 187,00
N IB0-0776-A01	C 82,00	KB0-2745-A01	C 109,00	MA0-1604	A 129,00	MA0-1747-A01	A 109,00	MA0-1862	A 268,00
N IB0-0777-A01	C 74,00	KB0-2746-A01	C	MA0-1605	A 240,00	MA0-1747-A02	A 133,00	MA0-1864	A 105,00
IC RACING SHOES / STIVALETTI RACING		KB0-2748-A01	C 41,00	MA0-1606	A 123,00	MA0-1749	A 192,00	MA0-1867	A 179,00
IC0-0784-B01	C 255,00	KB0-2749-A01	C 67,00	MA0-1608	A 145,00	MA0-1750	A 188,00	MA0-1868	A 115,00
IC0-0784-B02	L 304,00	KB0-2750-A01	C 38,00	MA0-1609	A 157,00	MA0-1751	A 105,00	MA0-1869	A 157,00
IC0-0805-B01	C 373,00	N KB0-2751-A01	C 115,00	MA0-1612	A 80,00	MA0-1752	A 153,00	MA0-1870	A 109,00
IC0-0818-A01	C	N KB0-2752-A01	C 99,00	MA0-1615	A 133,00	MA0-1753	A 170,00	MA0-1871	A 273,00
IC0-0819-B01	C	KC KARTING SHOES / SCARPE KARTING		MA0-1616	A 133,00	MA0-1754	A 158,00	MA0-1875	A 175,00
IC0-0822-A01	C 245,00	KC0-0815-A01	C 135,00	MA0-1623	A 135,00	MA0-1756	A 159,00	MA0-1877	A 157,00
IC0-0823-A01	C 213,00	KC0-0825-A01	C 99,00	MA0-1625	A 87,00	MA0-1757	A 279,00	MA0-1878	A 94,00
IC0-0824-A01	C 140,00	KC0-0826-A01	C 85,00	MA0-1626	A 71,00	MA0-1759	A 75,00	MA0-1879	A 151,00
IC0-0828-A01	C 189,00	KC0-0830-A01	C 109,00	MA0-1627	A 107,00	MA0-1761	A 131,00	MA0-1880	A 125,00
NVIC0-0829-A01	C 116,00	N KC0-0834-A01	C 225,00	MA0-1629	A 132,00	MA0-1762	A 50,50	MA0-1882	A 183,00
NVIC0-0831-A01	C 315,00	N KC0-0835-A01	C 199,00	MA0-1630	A 74,00	MA0-1763	A 85,00	MA0-1883	A 62,00
N IC0-0833-A01	C 290,00	KE KARTING UNDERWEAR / UNDERWEAR KARTING		MA0-1633	A 151,00	MA0-1764	A 163,00	MA0-1884	A 164,00
N IC0-0833-A02	L 0,00	KE0-3019-A01	C 15,50	MA0-1635	A 119,00	MA0-1766	A 133,00	MA0-1885	A 86,00
ID ACCESSORIES / ACCESSORI		KE0-3021-B01	C 67,00	MA0-1638	A 181,00	MA0-1767	A 133,00	MA0-1894	A 192,00
ID0-0787	C 69,00	KE0-3022-B01	C 62,00	MA0-1642	A 125,00	MA0-1768	A 156,00	MA0-1895	A 168,00
ID0-0789	C 99,00	KE0-3026-A01	C 22,00	MA0-1644	A 145,00	MA0-1770	A 145,00	MA0-1896	A 185,00
ID0-0790	C 84,00	NVKE0-3027-A01	C 7,50	MA0-1647	A 149,00	MA0-1771	A 152,00	MA0-1897	A 164,00
ID0-0791	C 64,00	N KE0-3028-A01	C 22,00	MA0-1648	A 71,00	MA0-1773	A 156,00	MA0-1898	A 194,00
N ID0-0806	C 139,00	N KE0-3028-AK1	C 22,00	MA0-1651	A 100,00	MA0-1781	A 136,00	MA0-1899	A 187,00
IE RACING UNDERWEAR / UNDERWEAR RACING		N KE0-3029-A01	C 55,00	MA0-1656	A 129,00	MA0-1782	A 153,00	MA0-1900	A 143,00
IE0-0762-A01	C 23,50	N KE0-3030-A01	C 48,00	MA0-1657	A 71,00	MA0-1783	A 158,00	MA0-1901	A 175,00
IE0-0766-A01	C 36,00	N KE0-3031-A01	C 22,00	MA0-1658	A 151,00	MA0-1784	A 93,00	MA0-1902	A 204,00
IE0-0766-A02	L 46,00	KK KARTING		MA0-1659	A 115,00	MA0-1785	A 115,00	MA0-1904	A 188,00
IE0-0770-A01	C 37,00	KK0-0008	C 29,00	MA0-1660	A 155,00	MA0-1787	A 168,00	MA0-1905	A 183,00
IE0-0771-A01	C 76,00	KK0-0036	C 33,50	MA0-1661	A 142,00	MA0-1788	A 120,00	MA0-1906	A 214,00
IE0-0772-A01	C 68,00	KK0-0047-B01	C 103,00	MA0-1663	A 175,00	MA0-1790	A 149,00	MA0-1907	A 206,00
IE0-0776-A01	C 33,00	KK0-0048-A01	C 139,00	MA0-1664	A 149,00	MA0-1791	A 152,00	MA0-1908	A 185,00
IE0-0785-A01	C 45,00	KK0-0049-A02	C 35,00	MA0-1666	A 135,00	MA0-1798	A 149,00	MA0-1909	A 89,00
IE0-0786-A01	C 54,00	KK0-0049-B01	C 315,00	MA0-1667	A 145,00	MA0-1804	A 156,00	MA0-1910	A 324,00
IE0-0787-A01	C 44,00	KK0-3106-A01	C 69,00	MA0-1668	A 93,00	MA0-1805	A 94,00	MA0-1911	A 159,00
IE0-0788-A01	C 35,00	KK0-3106-AK1	C 59,00	MA0-1669	A 188,00	MA0-1806	A 256,00	MA0-1912	A 159,00
IE0-0789-A01	C 44,00	KK0-3107-A01	C 63,00	MA0-1670	A 134,00	MA0-1809	A 139,00	MA0-1913	A 185,00
IE0-0790-A01	C 34,00	KK0-3201-A01	C 75,00	MA0-1672	A 102,00	MA0-1811	A 129,00	MA0-1915	A 94,00
IE0-0791-A01	C 75,00	KK0-3300-A01	C 45,00	MA0-1673	A 135,00	MA0-1812	A 220,00	MA0-1917	A 157,00
				MA0-1674	A 121,00	MA0-1813	A 135,00	MA0-1918	A 201,00
				MA0-1678	A 117,00	MA0-1816	A 169,00	MA0-1919	A 200,00
				MA0-1680	A 109,00	MA0-1817	A 79,00	MA0-1920	A 206,00

REF.	Euro	REF.	Euro	REF.	Euro	REF.	Euro	REF.	Euro
MA0-1923	A 168,00	N OBO-2979	P 80,00	OD0-1960-FI783A	A 95,00	OD0-1960-MA215	A 86,00	OD0-1960-RE883	A 76,00
MA0-1927	A 121,00	N OBO-2980	P 60,00	OD0-1960-FI790A	A 95,00	OD0-1960-MA218	A 72,00	OD0-1960-RE884	A 76,00
MA0-1930	A 181,00	N OBO-2981	P 105,00	OD0-1960-FI802	A 82,00	OD0-1960-ME855	A 105,00	OD0-1960-RE895	A 76,00
MA0-1931	A 197,00	N OBO-2982	P 130,00	OD0-1960-FI804	A 86,00	OD0-1960-ME906	A 105,00	OD0-1960-RE896	A 82,00
MA0-1937	A 181,00	N OBO-2983	P 150,00	OD0-1960-FI811	A 95,00	OD0-1960-ME954	A 95,00	OD0-1960-RO803	A 86,00
MA0-1938	A 245,00	OD STEERING WHEELS / VOLANTI		OD0-1960-FI818	A 86,00	OD0-1960-MG861	A 86,00	OD0-1960-RO875	A 76,00
NA RACING ACCESSORIES / ACCESSORI RACING		OD0-1960-FI822	A 76,00	OD0-1960-MI276	A 76,00	OD0-1960-RO888	A 76,00	OD0-1960-RO933	A 76,00
NA0-1564	C 5,40	OD0-1960-FI827	A 82,00	OD0-1960-MI279	A 82,00	OD0-1960-RO934	A 76,00	OD0-1960-RO935	A 76,00
NA0-1700-A01	C 22,50	OD0-1960-FI949	A 105,00	OD0-1960-MI280A	A 96,00	OD0-1960-RO936	A 76,00	OD0-1960-RO938	A 76,00
NA0-1700-A02	C 24,50	OD0-1960-FO29	A 82,00	OD0-1960-MI288	A 86,00	OD0-1960-RO939	A 86,00	OD0-1960-RO959	A 95,00
NA0-1819	C 54,00	OD0-1960-FO32	A 76,00	OD0-1960-MI290	A 86,00	OD0-1960-RO960	A 95,00	OD0-1960-RO966	A 86,00
NA0-1820	C 52,50	OD0-1960-FO32-1	A 76,00	OD0-1960-MI785A	A 105,00	OD0-1960-SA848	A 82,00	OD0-1960-SA849	A 76,00
NA0-1821	C 73,00	OD0-1960-FO36	A 76,00	OD0-1960-MI859	A 86,00	OD0-1960-SA850	A 82,00	OD0-1960-SB658	A 82,00
NA0-1822	C 42,00	OD0-1960-FO36-1	A 76,00	OD0-1960-MI907	A 86,00	OD0-1960-SB801	A 106,00	OD0-1960-SB866	A 76,00
NA0-1858	C 63,00	OD0-1960-FO36-2	A 86,00	OD0-1960-MI908	A 86,00	OD0-1960-SB867	A 76,00	OD0-1960-SB868	A 76,00
NA0-1859	C 27,50	OD0-1960-FO539	A 86,00	OD0-1960-MI910	A 76,00	OD0-1960-SB979	A 105,00	OD0-1960-SE881	A 76,00
NA0-1862	C 20,50	OD0-1960-FO541	A 95,00	OD0-1960-MS869	A 76,00	OD0-1960-SE882	A 76,00	OD0-1960-SK777A	A 95,00
NA0-1863	C 42,00	OD0-1960-FO542A	A 95,00	OD0-1960-NI307	A 86,00	OD0-1960-SK778A	A 86,00	OD0-1960-SK940	A 95,00
NA0-1864	C 86,00	OD0-1960-FO831	A 86,00	OD0-1960-NI310	A 76,00	OD0-1960-SK941	A 95,00	OD0-1960-SK942	A 95,00
NA0-1870	C 107,00	OD0-1960-FO862	A 86,00	OD0-1960-NI313	A 86,00	OD0-1960-SM600A	A 115,00	OD0-1960-SU761	A 76,00
NA0-1871	C 43,50	OD0-1960-FO863	A 86,00	OD0-1960-NI314	A 76,00	OD0-1960-SU766	A 76,00	OD0-1960-SU768	A 76,00
NA0-1875	C 239,00	OD0-1960-FO901	A 76,00	OD0-1960-NI315	A 76,00	OD0-1960-SU800	A 95,00	OD0-1960-SU812	A 95,00
NA0-1876	C 115,00	OD0-1960-FO922	A 86,00	OD0-1960-NI773	A 76,00	OD0-1960-SU928	A 95,00	OD0-1960-TO291	A 76,00
NA0-1877	C 299,00	OD0-1960-FO924	A 76,00	OD0-1960-NI781A	A 95,00	OD0-1960-TO292	A 76,00	OD0-1960-TO295	A 76,00
NA0-1880041	D 329,00	OD0-1960-FO958	A 95,00	OD0-1960-NI920	A 76,00	OD0-1960-TO298A	A 95,00	OD0-1960-TO299	A 76,00
N NA0-1884	C 129,00	OD0-1960-FO969	A 105,00	OD0-1960-NI921	A 76,00	OD0-1960-TO299-MA	A 76,00	OD0-1960-TO788A	A 95,00
NB MECHANICS' ACCESS. / ACCESS. PER MECCANICI		OD0-1960-GE927	A 76,00	OD0-1960-NI964	A 82,00	OD0-1960-TO912	A 95,00	OD0-1960-TO914	A 95,00
NB0-1579-A01	A 74,00	OD0-1960-HL870	A 76,00	OD0-1960-NI971	A 105,00	OD0-1960-TO956	A 95,00	OD0-1960-TO957	A 105,00
NB0-1579-AK1	A 72,00	OD0-1960-HL876	A 76,00	OD0-1960-NI972	A 135,00	OD0-1960-TR845	A 76,00	OD0-1960-UA847	A 76,00
NB0-1580-B01	A 95,00	OD0-1960-HL945	A 76,00	OD0-1960-OP580A	A 95,00	OD0-1960-VO247	A 76,00	OD0-1960-VO249	A 76,00
NB0-1580-B02	L 152,00	OD0-1960-HL946	A 76,00	OD0-1960-OP581A	A 95,00	OD0-1960-VO854	A 86,00	OD0-1960-VO905	A 86,00
NB0-1581-A01	A 99,00	OD0-1960-HO189	A 76,00	OD0-1960-OP72	A 86,00	OD0-1960-VO954	A 95,00	OD0-1960-VV145	A 86,00
NB0-1872	C 64,00	OD0-1960-HO2822	A 76,00	OD0-1960-OP779A	A 105,00	OD0-1960-VV149C	A 86,00	OD0-1960-VV237A	A 95,00
NB0-1885	C 18,00	OD0-1960-HO2823	A 76,00	OD0-1960-OP817	A 105,00	OD0-1960-VV238A	A 95,00	OD0-1960-VV239A	A 95,00
NB0-1894	C 30,00	OD0-1960-HO285	A 86,00	OD0-1960-OP87	A 76,00	OD0-1960-RE106	A 76,00		
NB0-1896-A01	C 26,00	OD0-1960-HO287	A 76,00	OD0-1960-PE190	A 86,00	OD0-1960-RE107C	A 76,00		
NC PIT ACCESSORIES / ACCESSORI PIT		OD0-1960-HO288	A 76,00	OD0-1960-PE193A	A 95,00	OD0-1960-RE108	A 76,00		
NC0-0072	A 45,00	OD0-1960-HO2882	A 76,00	OD0-1960-PE93A	A 95,00	OD0-1960-RE112	A 76,00		
NC0-0081	A 89,00	OD0-1960-HO285	A 86,00	OD0-1960-PE782A	A 95,00	OD0-1960-RE113	A 86,00		
NC0-1040	C 43,00	OD0-1960-HO56	A 72,00	OD0-1960-PE85	A 76,00	OD0-1960-RE114A	A 95,00		
NC0-1041	C 23,50	OD0-1960-HO772A	A 95,00	OD0-1960-PE87	A 76,00	OD0-1960-RE117A	A 95,00		
NC0-1067	C 121,00	OD0-1960-HO900	A 76,00	OD0-1960-PE87-1	A 76,00	OD0-1960-RE774A	A 105,00		
NC0-1068	C 148,00	OD0-1960-HO977	A 105,00	OD0-1960-PE89-1	A 76,00	OD0-1960-RE775A	A 84,00		
NC0-1069	C 71,00	OD0-1960-HO980	A 105,00	OD0-1960-PE89C	A 76,00	OD0-1960-RE787A	A 102,00		
OA PEDALS / PEDALIERE		OD0-1960-HY2851	A 76,00	OD0-1960-PE91-2	A 76,00	OD0-1960-RE879	A 86,00		
OA0-1000	A 29,00	OD0-1960-HY2853	A 86,00	OD0-1960-PE95A	A 86,00	OD0-1960-RE885	A 82,00		
OA0-1010	A 32,50	OD0-1960-HY85	A 86,00	OD0-1960-PE973	A 105,00	OD0-1960-RE885	A 82,00		
OA0-1020	A 25,00	OD0-1960-HY85	A 86,00	OD0-1960-PE974	A 105,00	OD0-1960-RE885	A 82,00		
OA0-1030	A 19,50	OD0-1960-CI143A	A 105,00	OD0-1960-PO806	A 76,00	OD0-1960-RE885	A 82,00		
OA0-1040	A 35,00	OD0-1960-CI144A	A 105,00	OD0-1960-PO839	A 76,00	OD0-1960-RE885	A 82,00		
OA0-1050	A 19,00	OD0-1960-CI780A	A 105,00	OD0-1960-PO840	A 76,00	OD0-1960-RE885	A 82,00		
OA0-1069	A 28,00	OD0-1960-CI786A	A 95,00	OD0-1960-PO841	A 82,00	OD0-1960-RE885	A 82,00		
OA0-1072	A 28,00	OD0-1960-CI944	A 76,00	OD0-1960-PO885	A 82,00	OD0-1960-RE885	A 82,00		
OA0-1863	A 18,00	OD0-1960-CI965	A 76,00	OD0-1960-PO92	A 76,00	OD0-1960-RE885	A 82,00		
OA0-1866	A 49,00	OD0-1960-CI968	A 105,00	OD0-1960-PO961	A 95,00	OD0-1960-RE885	A 82,00		
OA0-1867	A 28,00	OD0-1960-CI981	A 105,00	OD0-1960-PO967	A 95,00	OD0-1960-RE885	A 82,00		
OA0-2060	A 69,00	OD0-1960-CO810	A 92,00	OD0-1960-PO967	A 95,00	OD0-1960-RE885	A 82,00		
OA0-2070	A 29,00	OD0-1960-DA383	A 76,00	OD0-1960-RE106	A 76,00	OD0-1960-RE885	A 82,00		
OA0-2080	A 35,00	OD0-1960-DE5791	A 76,00	OD0-1960-RE106	A 76,00	OD0-1960-RE885	A 82,00		
OB SPORTSWEAR		OD0-1960-DE5792	A 76,00	OD0-1960-RE106	A 76,00	OD0-1960-RE885	A 82,00		
N OBO-2978	P 60,00	OD0-1960-DE770	A 76,00	OD0-1960-RE106	A 76,00	OD0-1960-RE885	A 82,00		
		OD0-1960-FI04	A 82,00	OD0-1960-RE106	A 76,00	OD0-1960-RE885	A 82,00		
		OD0-1960-FI10	A 72,00	OD0-1960-RE106	A 76,00	OD0-1960-RE885	A 82,00		
		OD0-1960-FI20	A 76,00	OD0-1960-RE106	A 76,00	OD0-1960-RE885	A 82,00		
		OD0-1960-FI21	A 76,00	OD0-1960-RE106	A 76,00	OD0-1960-RE885	A 82,00		
		OD0-1960-FI24	A 82,00	OD0-1960-RE106	A 76,00	OD0-1960-RE885	A 82,00		
		OD0-1960-FI25	A 96,00	OD0-1960-RE106	A 76,00	OD0-1960-RE885	A 82,00		
		OD0-1960-FI26	A 82,00	OD0-1960-RE106	A 76,00	OD0-1960-RE885	A 82,00		
		OD0-1960-FI769A	A 95,00	OD0-1960-RE106	A 76,00	OD0-1960-RE885	A 82,00		
		OD0-1960-FI771	A 76,00	OD0-1960-RE106	A 76,00	OD0-1960-RE885	A 82,00		
		OD0-1960-LO877	A 76,00	OD0-1960-RE106	A 76,00	OD0-1960-RE885	A 82,00		
		OD0-1960-LO878	A 76,00	OD0-1960-RE106	A 76,00	OD0-1960-RE885	A 82,00		
		OD0-1960-LO879	A 86,00	OD0-1960-RE106	A 76,00	OD0-1960-RE885	A 82,00		

REF.	Euro	REF.	Euro	REF.	Euro	REF.	Euro	REF.	Euro	
OD0-1960-VW776A	A 95,00	PC CHEMICAL PRODUCTS / PRODOTTI CHIMICI	N SC0-0617-A02	C 189,00						
OD0-1960-VW851	A 86,00		SC0-0726	D 58,00						
OD0-1960-VW852	A 86,00		PC0-1001	A 15,00	SC0-0730	C 133,00				
OD0-1960-VW853	A 86,00		PC0-2001	A 18,00	SC0-0790-B01	C 340,00				
OD0-1960-VW902	A 86,00		PC0-2002	A 17,00	SC0-0799-B01	C 399,00				
OD0-1960-VW982	A 105,00		PC0-2003	C 24,00	SC0-0799-B02	C 365,00				
OD0-1960-YU508	A 86,00		PC0-2005	P 9,80	SC0-0801-A01	C 319,00				
OD0-1972	C 175,00		PC0-2006	P 12,30	SC0-179071	C 24,00				
OD0-1975	C 175,00		PC0-2007	P 9,40						
OD0-1976	C 185,00		PR PROMOTIONAL ITEM / PRODOTTO PROMOZ.	T0 TYRE WARMERS / COPERTE TERMICHE						
OD0-1979	C 189,00	PR0-0880		P 4,60	T00-0200-A01	C 971,00				
OD0-1980	C 199,00	PR0-0908		P 11,80	T00-0200-A02	C 1.525,00				
OD0-1981	A 129,00	PR0-0918-A01		P 6,60	T00-1957-A01	C 584,00				
OD0-1985	C 230,00	PR0-0918-AK1		P 6,60	T00-1957-A02	C 655,00				
OD0-1987	C 210,00	PR0-0922		P 242,00	T00-1963-A01	C 611,00				
OD0-1989	A 129,00	PR0-0934		P 7,80	T00-1963-A02	C 682,00				
OD0-1990	C 195,00	PR0-0935		P 2,60	T00-2360-A01	C 611,00				
OD0-2005	C 185,00	PR0-0936		P 50,00	T00-2360-A02	C 682,00				
OD0-2012	C 210,00	PR0-0937		P 24,00	T00-2363-A01	C 611,00				
OD0-2017	C 225,00	PR0-0938	P 24,00	T00-2363-A02	C 682,00					
OD0-2018	A 139,00	N PR0-0940	P 25,00	X0 OTHER						
OD0-2019	A 139,00	N PR0-0941	P 22,00		N X00-690-K01	P 9,00				
OD0-2020	C 270,00	SC HELMETS AND ACCESS. / CASCHI E ACCESSORI	N X00-690-R01		P 9,00					
OD0-2021	C 270,00		SC0-0020		C 13,50	N X00-693-GLV	P 5,50			
OD0-2023	C 109,00		SC0-0066		C 56,00	N X00-693-SUIT	P 10,00			
OD0-2026	C 114,00		SC0-0067		C 138,00	N X00-693-UND-BL	P 5,50			
OD0-2028	C 650,00		SC0-0153		C 11,60	N X00-693-UND-TP	P 6,00			
OD0-2029	C 88,00		SC0-0160		C 63,00	X00-694E-15	P 12,60			
OD0-2030	C 210,00		SC0-0161		C 66,00	X00-694E-80TNT	P 3,60			
OD0-2031	C 149,00		SC0-0162		C 82,00	X00-846	P 3,90			
OD0-2032	C 780,00		SC0-0163	C 87,00	X00-867	P 66,00				
OD0-2034	C 320,00		SC0-0164	C 14,00	X00-889	P 2,80				
OD0-2035	C 320,00	SC0-0165	C 19,00	X00-963	P 89,00					
OD0-2042-A01	C 270,00	SC0-0166	C 18,50	X00-963-CINT	P 66,00					
OD0-2042-A02	C 270,00	SC0-0167	C 18,50	XH OTHER						
N OD0-2042-A03	C 270,00	SC0-0168	C 56,00		XHA-806-KIT	C 75,00				
OD0-2044	C 450,00	SC0-0172	C 41,50	XM OTHER						
OD0-2046	C 280,00	SC0-0176	C 63,00		XMC-181493	C 6,20				
OD0-2048	D 1.350,00	SC0-0177	C 48,50		XMC-363-E-CAV	C 29,50				
OD0-2052-B01	C 146,00	SC0-0178	C 11,60		XMC-398-CAV	C 16,00				
OD0-2055	C 165,00	SC0-0179	C 42,00		XMC-CAB-360E	C 52,00				
OM OFFICIAL LICENSED PRODUCT		SC0-0180	C 12,70		XMD-437	C 75,00				
	OMPS00011503	P 245,00	SC0-0181		C 16,50	XMO-1960	A 5,20			
	OMPS00021503	P 245,00	SC0-0182		C 79,00					
	OMPS18010619	P 59,95	SC0-0184		C 7,00					
	OMPS18010819	P 64,95	SC0-0185		C 18,50					
	OMPS18011019	P 64,95	SC0-0186	C 18,50						
	OMPS18040713	P 94,95	SC0-0187	C 8,40						
	OMPS18040913	P 94,95	SC0-0188	C 8,40						
	OMPS1911	P 24,95	SC0-0189	C 8,40						
	OMPS20001809	P 699,00	SC0-0190	C 8,40						
OMPS20002009	P 799,00	SC0-0194	C 25,00							
OMPS9001	P 64,95	SC0-0195	C 63,00							
OMPS9002	P 64,95	SC0-0196	C 71,00							
OS QUICK RELEASE / SGANCI R APIDI		SC0-0197	C 88,00							
	OS0-0023	A 119,00	N SC0-0198	C 19,00						
	OS0-0024-A01	C 234,00	N SC0-0199	C 19,00						
	OS0-0024-A02	C 409,00	N SC0-0200	C 8,40						
	OS0-0024-A03	C 259,00	N SC0-0201	C 8,00						
	OS0-0024-A04	C 419,00	N SC0-0202	C 8,00						
	OS0-0025-A01	C 244,00	SC0-0607-B01	C 65,00						
	OS0-0025-A02	C 264,00	N SC0-0616-A01	C 109,00						
			N SC0-0617-A01	C 89,00						

R	Art	Euro	Description	Colour	Size	Layer	Homol.
FIRE RETARDANT SUITS							
	IAO-1861-A01	1.279,00	C ONE EVO X Suit: Top level ultra-light racing suit made with new generation fabrics that guarantees more lightness (in comparison to previous ONE EVO model) and more safety (FIA 8856-2018 homologation). Breathable material inserts on back, hips, legs for maximum cooling - "DRY SYSTEM" light stretch technology. Two layers construction, ultralight soft inner fabrics, high breathability material inserts, hidden outer pocket, belt less. Fishbone quilting.	Black (IAO-1861-A01-071-XX) Silver/black (IAO-1861-A01-083-XX) Navy blue/cyan (IAO-1861-A01-246-XX) Black/red (IAO-1861-A01-073-XX) Black/Fluo yellow (IAO-1861-A01-178-XX)	46÷64	2	FIA 8856 -2018
	IAO-1862-A01		C ONE EVO X SL Suit: Top level extremely lightweight race suit. Same ONE EVO X new generation fabrics for extreme lightness (approximately 700gr in size 48) AVAILABLE ONLY UPON REQUEST	Custom	Upon request	2	FIA 8856 -2018
N	IAO-1869-A01		C ONE EVO X GT Suit: Extremely comfortable version of ONE EVO X Suit (with elastic knees and elastic inserts on back) AVAILABLE ONLY UPON REQUEST	Custom	Upon request	2	FIA 8856 -2018
	IAO-1860-A01	1.099,00	C ONE-S Suit: Fire retardant top level overall. Developed for the highest lightness without sacrificing the comfort. Semi floating arm bellows, legs and inner collar inserts in soft knitted elastic fabric. Breathable and elastic inserts in new stretch Dry System fabric on lumbs. High breathability parts in Dry System 3D material on low back, hips, neck and under the sleeves. Regular fit, with ultraflat antirubbing seams, soft knitted inside and a comfortable hidden inner pocket. With belt to improve fitting.	Black (IAO-1860-A01-071-XX) Silver (IAO-1860-A01-083-XX) Navy blue/orange (IAO-1860-A01-249-XX)	46÷64	3	FIA 8856 -2018
	IAO-1857-B01	1.099,00	C ONE ART Suit: Totally printed FIA top level suit. High comfort thanks to semi floating arm bellows, legs and inner collar inserts in soft knitted elastic fabric. Breathable and elastic inserts ("Stretch Dry System" technology) on lumbs. High breathability parts in Dry System 3D material on back, hips and under the sleeves. Regular fit with ultraflat antirubbing seams, soft knitted fabric inside and two comfortable hidden pockets. Unlimited customization thanks to the totally printed design.	Black/yellow (IAO-1857-B01-072-XX)	46÷64	3	FIA 8856 -2018
	IAO-1859-B01	810,00	C TECNICA EVO Suit: Professional fire retardant suit featured by high-level fabrics. Floating arms with elastic bellows to increase freedom of movement, breathable fabric inserts to give the best comfort. Ultraflat antirubbing seams, inner fabric made in soft knitted fabric and practical front pocket on right side. "Fishbone" quilting, fresh and aggressive design.	Black/red (IAO-1859-B01-073-XX) Black/white (IAO-1859-B01-076-XX) White/anthracite (IAO-1859-B01-373-XX) Navy blue/cyan (IAO-1859-B01-246-XX) Black/anthracite/fluo yellow (IAO-1859-B01-178-XX) Red/black (IAO-1859-B01-060-XX)	44÷64	3	FIA 8856 -2018
	IAO-1864-A01	599,00	C TECNICA Hybrid Suit: Professional racing suit make use of traditional Nomex fabrics mixed with high technology printed inserts and high quality embroidered details. Floating sleeves with elastic bellow, knitted elastic insert on the back for maximum freedom of movement. Shaped collar with inner soft knitted fabric, adjustable velcro's belt, ultra-flat anti-rubbing seams and soft insert on groin guarantee maximum comfort. Breathable inserts on hips and under the sleeves, pockets with diagonal cut on front, fishbone quilting.	Black/silver (IAO-1864-A01-171-XX) Black/fluo yellow (IAO-1864-A01-178-XX) Navy blue/cyan (IAO-1864-A01-244-XX) Red/black (IAO-1864-A01-060-XX) Silver/black (IAO-1864-A01-089-XX)	44÷64		FIA 8856 -2018
	IAO-1854-B01	469,00	C FIRST EVO Suit: Two layer overall with modern two-tone design featuring an excellent quality/comfort/price ratio. External layer in aramidic fiber for high use and washing resistance, inner fabric in soft knitted material. Floating sleeves, antirubbing ultra flat seams. Elasting inserts on the back and on the groins for better comfort and flexibility. Breathable inserts on the sleeves, comfortable hidden inner pocket.	Black/white (IAO-1854-B01-076-XX) Red/white (IAO-1854-B01-063-XX) Navy blue/white/cyan (IAO-1854-B01-244-XX) Silver/black (IAO-1854-B01-089-XX) Anthracite/black/fluo yellow (IAO-1854-B01-184-XX)	42÷64	2	FIA 8856 -2018
	IAO-1854-B02	449,00	C FIRST ELLE Suit: Two-layer overall with modern two-tone design featuring an excellent quality/comfort/price ratio. External layer in aramidic fiber for high use and washing resistance, inner fabric in soft knitted material. Floating sleeves, antirubbing ultra flat seams. Elastic inserts on the back and on the groins for better comfort and flexibility. Breathable inserts on the sleeves. SPECIAL SHAPE FOR LADIES.	Navy blue/tiffany (IAO-1854-B02-248-XX) Black/white (IAO-1854-B02-076-XX) Black/fuchsia (IAO-1854-B02-277-XX)	38÷50	2	FIA 8856 -2018

R	Art	Euro		Description	Colour	Size	Layer	Homol.
NV	IA0-1828-E01	359,00	C	FIRST-S Suit my2024: Entry level FIA homologated racing suit made with lightweight fabrics and with an excellent price/quality/resistance/comfort ratio. Inner layer in soft knitted fire retardant fabric, ultraflat antirubbing seams, floating arms with elastic bellows and knitted elastic insert on the back for maximum freedom of movement. Modern design with "fishbone" quilting. NEW POCKET DESIGN	Black (IA0-1828-E01-071-XX) Silver (IA0-1828-E01-083-XX) Navy blue/cyan (IA0-1828-E01-244-XX) Red (IA0-1828-E01-061-XX) Anthracite/fluo yellow (IA0-1828-E01-184-XX)	44÷64	2	FIA 8856 -2018
NV	IA0-1847-C01	299,00	C	OMP SPORT Suit my2024: Entry level racing suit with an excellent quality/price ratio. Two layers, made of Nomex® fabric with soft knitted fabric inserts on the back for a great comfort and freedom of movements. NEW SHOULDER AND BACK WITH OMP LOGO	Black (IA0-1847-C01-071-XXX) Red (IA0-1847-C01-061-XXX) Blue (IA0-1847-C01-041-XXX)	S=XXL	2	FIA 8856 -2018
N	IA0-1901-B01	189,00	C	OS10 Suit my2024: One layer racing suit in fire retardant fabric. Treated woven fabric, double back pleat for additional comfort, lumbar elastic stretch, external pockets. With driver extraction handles, matt finish. NEW OMP DESIGN	Black (IA0-1901-B01-071-XX)	S=XXL	1	SFI SFI 3.2
VINTAGE SUITS								
	IA0-1842-B01	1.039,00	C	ONE Vintage Suit: Three layers top level racing suit, typical style worn by the great champions of F1 in the mid '60s revived with the latest ultralightweight fabrics (same top level material of ONE-S suit). Shaped collar, precurved sleeves and ultra-flat antirubbing seams. Rear elastic insert to increase comfort.	Black with white stripes (IA0-1842-B01-071-XX)	46÷64	3	FIA 8856 -2018
	IA0-1816-C01	599,00	C	Classic Suit: Two layers racing suit with vintage '70 design given by the 2 vertical stripes on the chest. Inner collar in soft knitted fabric. Outer layer in fire retardant fiber, inner layer in comfortable breathable knitted fabric.	Ecru' with two light blue/orange stripes (IA0-1816-C01-028-XX) Navy blue with two cream/orange stripe (IA0-1816-C01-042-XX) Red with white/black stripes (IA0-1816-C01-061-XX)	46÷64	2	FIA 8856 -2018
KART SUITS								
N	KA0-1731-A01	435,00	C	KS-X Art Suit: Top level ultra light and totally printed karting suit. Developed with the most important karting teams and drivers. Without seams on waist and lateral seams moved on front to increase driver's comfort whilst on the karting seat. Ultrasoft resistant fabrics, elastics insert on groin, underfoot retainer, protective and comfortable padding on knees, high breathability inserts under the sleeves, low cut neck. Floating arms with elastic bellow, stretch insert on back. Unlimited customization ways. NEW FIA 8877-2022 HOMOLOGATION.	Black/yellow/red (KA0-1731-A01-378-XX)	42÷62	3	FIA 8877 -2022
N	KA0-1731-AK1	405,00	C	KS-X Art Suit Kids: Top level ultra light and totally printed karting suit. Developed with the most important karting teams and drivers. Without seams on waist and lateral seams moved on front to increase driver's comfort whilst on the karting seat. Ultrasoft resistant fabrics, elastics insert on groin, underfoot retainer, protective and comfortable padding on knees, high breathability inserts under the sleeves, low cut neck. Floating arms with elastic bellow, stretch insert on back. Unlimited customization ways. NEW FIA 8877-2022 HOMOLOGATION.	Black/yellow/red (KA0-1731-AK1-378-XX)	120÷160 (height in cm)	3	FIA 8877 -2022
	KA0-1726-B01	429,00	C	KS ART Suit: Top level ultra light and totally printed karting suit. Developed with the most important karting teams and drivers. Without seams on waist and seams moved on front to increase driver's comfort. Elastics insert on groin, underfoot retainer, comfortable padding on knees, high breathability inserts under the sleeves, mesh inserts on shoulder and pockets to improve ventilation, low cut neck and velcro wrist closure. Floating arms with elastic bellow and elastic insert on back.	Black/fluo yellow (KA0-1726-B01-178-XX)	44÷62	2	CIK-FIA 2001/90/lev el 2 2013-1
	KA0-1726-BK1	392,00	C	KS ART Suit Kids: Top level ultra light and totally printed karting suit. Developed with the most important karting teams and drivers. Without seams on waist and seams moved on front to increase driver's comfort. Elastics insert on groin, underfoot retainer, comfortable padding on knees, high breathability inserts under the sleeves, mesh inserts on shoulder and pockets to improve ventilation, low cut neck and velcro wrist closure. Floating arms with elastic bellow and elastic insert on back. FOR KIDS.	Black/fluo yellow (KA0-1726-BK1-178-XX)	120÷160 (height in cm)	2	CIK-FIA 2001/90/lev el 2 2013-1
	KA0-1730-A01	205,00	C	KS-3 ART Suit: Comfortable and resistant karting suit made in lightweight external fabrics and soft kitted inner lining. Breathable mesh inserts on legs, crotch and under the sleeves to get best ventilation, low cut neck collar and elastic insert on the back to improve fitting and comfort. Two practical outer pockets, exclusive no-belt printed design featured by 'motorcycle suit inspired' zip closure.	Black/silver (KA0-1730-A01-171-XX) Red/black (KA0-1730-A01-073-XX) Blue/cyan (KA0-1730-A01-244-XX) Black/fluo yellow (KA0-1730-A01-178-XX)	42÷62	3	CIK-FIA 2001/90/lev el 2 2013-1

R	Art	Euro	Description	Colour	Size	Layer	Homol.
	KA0-1730-AK1	195,00	C KS-3 ART Suit Kids: Comfortable and resistant karting suit made in lightweight external fabrics and soft kitted inner lining. Breathable mesh inserts on legs, crotch and under the sleeves to get best ventilation, low cut neck collar and elastic insert on the back to improve fitting and comfort. Two practical outer pockets, exclusive no-belt printed design featured by 'motorcycle suit inspired' zip closure. FOR KIDS.	Black/silver (KA0-1730-AK1-171-XX) Red/black (KA0-1730-AK1-073-XX) Blue/cyan (KA0-1730-AK1-244-XX) Black/fluo yellow (KA0-1730-AK1-178-XX)	120÷160 (height in cm)	3	CIK-FIA 2001/90/lev el 2 2013-1
	KA0-1727-A01	179,00	C KS-3 Suit: Comfortable and resistant karting suit made in lightweight external fabrics and soft kitted inner lining. Breathable mesh inserts on legs, crotch and under the sleeves to get best ventilation, low cut neck collar and elastic insert on the back to improve fitting and comfort. Two practical outer pockets, modern and fresh design featured by exclusive belt and 'motorcycle suit inspired' zip closure. Wide range of colors and sizes, also available for children.	Black (KA0-1727-A01-071-XX) Red/black (KA0-1727-A01-073-XX) Grey/black (KA0-1727-A01-089-XX) Blue/cyan (KA0-1727-A01-242-XX) Fluo orange/black (KA0-1727-A01-179-XX) Fluo yellow/black (KA0-1727-A01-178-XX) Fluo green/black (KA0-1727-A01-274-XX)	42÷62	3	CIK-FIA 2001/90/lev el 2 2013-1
	KA0-1727-AK1	169,00	C KS-3 Suit Kids: Comfortable and resistant karting suit made in lightweight external fabrics and soft kitted inner lining. Breathable mesh inserts on legs, crotch and under the sleeves to get best ventilation, low cut neck collar and elastic insert on the back to improve fitting and comfort. Two practical outer pockets, modern and fresh design featured by exclusive belt and 'motorcycle suit inspired' zip closure. Wide range of colors and sizes. FOR KIDS.	Black (KA0-1727-AK1-071-XX) Red/black (KA0-1727-AK1-073-XX) Grey/black (KA0-1727-AK1-089-XX) Blue/cyan (KA0-1727-AK1-242-XX) Fluo orange/black (KA0-1727-AK1-179-XX) Fluo yellow/black (KA0-1727-AK1-178-XX) Fluo green/black (KA0-1727-AK1-274-XX)	120÷160 (height in cm)	3	CIK-FIA 2001/90/lev el 2 2013-1
	KA0-1728-A01	135,00	C KS-4 Suit: Entry level karting suit. Outer layer in resistant polyester fabric, interior in soft cotton sponge. Low cut neck collar, arm bellow in elastic knitted fabric for maximum freedom of movement. Mesh inserts for ventilation on legs, shoulder and pocket.	Red (KA0-1728-A01-061-XX) Black (KA0-1728-A01-071-XX) Blue (KA0-1728-A01-041-XX)	S-XXL	4	CIK-FIA 2001/130/lev 1 2013-1
	KA0-1728-AK1	125,00	C KS-4 Suit Kids: Entry level karting suit. Outer layer in resistant polyester fabric, interior in soft cotton sponge. Low cut neck collar, arm bellow in elastic knitted fabric for maximum freedom of movement. Mesh inserts for ventilation on legs, shoulder and pocket. FOR KIDS.	Red (KA0-1728-AK1-061-XX) Black (KA0-1728-AK1-071-XX) Blue (KA0-1728-AK1-041-XX)	120÷150 (height in cm)	4	CIK-FIA 2001/130/lev 1 2013-1
	KA0-1719-A01	83,00	C SUMMER-K Suit - One layer karting suit. Made of very lightweight and durable cotton fabric, ideal for indoor karting.	Red (KA0-1719-A01-061-XX) Black (KA0-1719-A01-071-XX) Blue (KA0-1719-A01-041-XX)	S-XXL	1	
	KA0-1719-AK1	78,00	C SUMMER-K Suit Kids - One layer karting suit. Made of very lightweight and durable cotton fabric, ideal for indoor karting. FOR KIDS.	Red (KA0-1719-AK1-061-XX) Black (KA0-1719-AK1-071-XX) Blue (KA0-1719-AK1-041-XX)	120÷150 (height in cm)	1	
MECHANICS' SUITS							
	NB0-1581-A01	99,00	A X Mech Stretch Suit: Ultra comfortable mechanic's overall made in stretch 4-way fabric. The new generation ultralightweight material water resistant, breathable and windproof guarantees a next-level of comfort and freedom of movement. Removable shaped knee pads in EVA. Elastic wrist closure and ankles with velcro strap to improve fitting, two large sized pocket on front, front pocket with zipper on chest. Aggressive design with racing-inspired shoulders with handle, "OMP" custom zip puller in rubber and highlighted stitching on arms and legs.	Black (NB0-1581-A01-071-XX)	44÷64	1	
	NB0-1580-B01	95,00	A BLAST EVO: Mechanics suit made of lightweight and resistant polyester and cotton fabrics. The knitted elastic fabric inserts on back and hips and the comfortable arm-bellows guarantee the best freedom of movements. Several practical pockets to store tools and parts: two large-sized on the legs, two with zip closure (one on the right leg and one on the chest) and an inner one on the chest. Removable shaped knee pads. Elastic wrist closure and ankles with velcro strap to improve fitting. Aggressive design with racing-inspired shoulders and highlighted stitching.	Black (NB0-1580-B01-071-XX) Red (NB0-1580-B01-061-XX) Blue (NB0-1580-B01-041-XX) Grey (NB0-1580-B01-082-XX)	44÷64	1	

R	Art	Euro	Description	Colour	Size	Layer	Homol.
NB0-1579-A01	74,00	A	SUMMER: Summer type suit made of polyester/cotton fabric. Inner pocket designed for holding tools. Padded panel inserts on knees, elastic wrist closure, leg cuffs with velcro closure. Two front pockets on legs, pocket on right leg designed for holding tools.	Blue (NB0-1579-A01-041-XX) Black (NB0-1579-A01-071-XX) Red (NB0-1579-A01-061-XX)	44÷64	1	
NB0-1579-AK1	72,00	A	SUMMER Kids: Summer type suit made of polyester/cotton fabric. Inner pocket designed for holding tools. Padded panel inserts on knees, elastic wrist closure, leg cuffs with velcro closure. Two front pockets on legs, pocket on right leg designed for holding tools. FOR KIDS.	Blue (NB0-1579-AK1-041-XX) Black (NB0-1579-AK1-071-XX) Red (NB0-1579-AK1-061-XX)	120÷150 (height in cm)	1	

UNDERWEAR AND ACCESSORIES

Descriptive List

R	Ref	Euro	Description	Colour	Size	Homolog.
FIRE RETARDANT UNDERWEAR - BALACLAVA						
IEO-0791-A01	75,00	C	ONE EVO Balaclava: Top level balaclava made with comfortable fire retardant seamless fabric that ensures the best comfort. Two later seams on top for the best fitting. Two sizes available.	White (IEO-0791-A01-020-XX) Black (IEO-0791-A01-071-XX)	S/M L/XL	FIA 8856-2018
IEO-0794-A01	67,00	C	TECNICA EVO Balaclava: Open face balaclava with ultra-flat seams. Advanced technology knitted fabric with high breathability 3D knitted inserts for maximum cooling in hot condition and anatomic shape for best fitting and comfort. Two sizes available.	White (IEO-0794-A01-020-XX) Black (IEO-0794-A01-071-XX)	S M	FIA 8856-2018
IEO-0770-A01	37,00	C	FIRST Balaclava: Entry level fire retardant balaclava with flat seams. Available in two sizes: medium as standard size and a smaller one.	White (IEO-0770-A01-020-XXX) Black (IEO-0770-A01-071-XXX)	S M	FIA 8856-2018
FIRE RETARDANT UNDERWEAR - TOP						
IEO-0792-A01	149,00	C	ONE EVO Top: Top level long sleeved underwear top with high neck for maximum protection made with a comfortable fire retardant seamless fabric. The high breathability fabric inserts "3D cube" on main perspiration areas ensures the best comfort and a perfect fitting (3D Dry System Technology).	White (IEO-0792-A01-020-XX) Black (IEO-0792-A01-071-XX)	XS/S (42-46) M (48-50) L (52-54) XL/XXL (56-58) XXXL (60-64) upon request	FIA 8856-2018
IEO-0795-A01	134,00	C	TECNICA EVO Top: Stretched long sleeved crew-neck top. Ultra-flat and anti-rubbing seams. Advanced technology knitted fabric with high breathability 3D knitting inserts for maximum cooling in hot condition that alignes with the breathable inserts of 'ONE' range suits and TECNICA EVO suits - DRY SYSTEM tecnology. Prepared for cooling treatment activated with special spray (PC02003 - sold separately).	White (IEO-0795-A01-020-XX) Black (IEO-0795-A01-071-XX)	XS/S (42-46) M (48-50) L (52-54) XL (56-58) XXL (60-64)	FIA 8856-2018
IEO-0771-A01	76,00	C	FIRST Top: Entry level fire retardant underwear top with flat seams, shaped neck and raglan sleeves to increase comfort. Regular fit, also available for children (two size).	White (IEO-0771-A01-020-XXX) Black (IEO-0771-A01-071-XXX)	XS S M L XL XXL For children: 8/10 years 10/12 years	FIA 8856-2018
FIRE RETARDANT UNDERWEAR - PANTS						
IEO-0793-A01	125,00	C	ONE EVO Pants: Top level underwear pants made with a comfortable fire retardant seamless fabric. The high breathability fabric inserts "3D cube" on main perspiration areas ensures the best comfort and a perfect fitting (3D Dry System Technology).	White (IEO-0793-A01-020-XX) Black (IEO-0793-A01-071-XX)	XS/S (42-46) M (48-50) L (52-54) XL/XXL (56-58) XXXL (60-64) upon request	FIA 8856-2018
IEO-0796-A01	104,00	C	TECNICA EVO Pants: Stretched long johns with ultra-flat seams. Advanced technology knitted fabric with high breathability 3D knitting inserts for maximum cooling in hot condition that alignes with the breathable inserts of 'ONE' range suits and TECNICA EVO suits - DRY SYSTEM tecnology. Prepared for cooling treatment activated with special spray (PC02003 - sold separately).	White (IEO-0796-A01-020-XX) Black (IEO-0796-A01-071-XX)	XS/S (42-46) M (48-50) L (52-54) XL (56-58) XXL (60-64)	FIA 8856-2018
IEO-0772-A01	68,00	C	FIRST Pants: Entry level fire retardant underwear pants with flat seams, tight ankle and elastic on waist to increase comfort. Regular fit, also available for children (two size).	White (IEO-0772-A01-020-XXX) Black (IEO-0772-A01-071-XXX)	XS S M L XL XXL For children: 8/10 years 10/12 years	FIA 8856-2018
FIRE RETARDANT UNDERWEAR - SOCKS						
IEO-0766-A01	36,00	C	ONE EVO Socks: Technical socks made with advanced knitting techniques to provide differentiated pressure areas, with beneficial effect on blood circulation, reducing the feeling of fatigue on the legs while driving.	White (IEO-0766-A01-020-XX) Black (IEO-0766-A01-071-XX)	S-M-L	FIA 8856-2018
IEO-0776-A01	33,00	C	TECNICA EVO Socks: Technical socks made with advanced knitting techniques to provide differentiated pressure areas with beneficial effect on blood circulation and breathability. Anatomic shape, reinforced tip and heel.	White (IEO-0776-A01-020-XXX) Black (IEO-0776-A01-071-XXX)	S-M-L	FIA 8856-2018

R	Ref	Euro	Description	Colour	Size	Homolog.
	IE0-0762-A01	23,50	C FIRST Socks: Knitted fire retardant fabric socks. Mid-length.	White (IE0-0762-A01-028) Black (IE0-0762-A01-071)	XS-S-M-L	FIA 8856-2018
FIRE RETARDANT - BOXER, BRA, SLIP						
	IE0-0786-A01	54,00	C ONE EVO Bra: FIA homologated fire retardant bra for women in comfortable stretch seamless fabric.	Black (IE0-0786-A01-071-XX)	XS (38-40) S (42) M (44) L (46) XL (48-50)	FIA 8856-2018
	IE0-0785-A01	45,00	C ONE EVO Boxer: FIA homologated fire retardant boxer for men in comfortable stretch seamless fabric.	Black (IE0-0785-A01-071-XX)	S (42-46) M (48-50) L (52-54) XL (56-58) XXL (60-64)	FIA 8856-2018
	IE0-0787-A01	44,00	C ONE EVO Slip: FIA homologated fire retardant slip for women in comfortable stretch seamless fabric.	Black (IE0-0787-A01-071-XX)	XS (38-40) S (42) M (44) L (46) XL (48-50)	FIA 8856-2018
	IE0-0789-A01	44,00	C TECNICA EVO Bra: FIA homologated fire retardant bra for women in comfortable stretch seamless fabric.	Black (IE0-0789-A01-071-XX)	XS (38-40) S (42) M (44) L (46) XL (48-50)	FIA 8856-2018
	IE0-0788-A01	35,00	C TECNICA EVO Boxer: FIA homologated fire retardant boxer for men in comfortable stretch seamless fabric.	Black (IE0-0788-A01-071-XX)	S (42-46) M (48-50) L (52-54) XL (56-58) XXL (60-64)	FIA 8856-2018
	IE0-0790-A01	34,00	C TECNICA EVO Slip: FIA homologated fire retardant slip for women in comfortable stretch seamless fabric.	Black (IE0-0790-A01-071-XX)	XS (38-40) S (42) M (44) L (46) XL (48-50)	FIA 8856-2018
FIRE RETARDANT ACCESSORIES						
N	ID0-0806	139,00	C ONE-V Cooling Vest: Cooling vest with water filled system that keep the body fresh in high temperature condition. The ultralightweight three layers construction features an innovative heat expulsion system that give a constant cooling sensation. The stretch fabric inserts on side make the vest ultra comfortable to wear during a racing break.	Grey (ID0-0806-080-XX)	S M L XL	
	ID0-0789	99,00	C Anatomic, round neck collar knit Nomex® for improved comfort. Insert in Nomex® fabric. Padded in high density foam.	Black (ID0-0789-071)	One Size	
	ID0-0790	84,00	C Nomex® knee pads with inner padding.	Black (ID0-0790-071)	One Size	
	ID0-0787	69,00	C U shaped neck collar in Nomex® fibre. Padding in high density foam. Particularly in case of accident.	Black (ID0-0787-071)	One Size	
	ID0-0791	64,00	C Nomex® elbow pads with inner padding.	Black (ID0-0791-071)	One Size	
	PC0-2003	24,00	C Cool treatment spray activator for ONE Underwear. The treatment is not available on 2013 ONE underwear.			
KARTING UNDERWEAR						
	KE0-3021-B01	67,00	C KS Winter-R Shirt: Underwear long sleeved shirt made with new materials, the seamless fabric's weave allow a fast sweat expulsion. Developed with the most important karting teams and drivers, the shirt ensures an increased comfort and an excellent freedom of movement, and represents the best solution for karting or playing other sports in winter. Modern and fresh design.	Black (KE0-3021-B01-071-XX)	S/M (44-48) L/XL (50-54) XXL/XXXL (56-60) 8/10 years 10/12 years	
	KE0-3022-B01	62,00	C KS Winter-R Pants: Underwear long johns made with new materials, the seamless fabric's weave allow a fast sweat expulsion. Developed with the most important karting teams and drivers, the pants ensures an increased comfort and an excellent freedom of movement, and represents the best solution for karting or playing other sports in winter. Modern and fresh design.	Black (KE0-3022-B01-071-XX)	S/M (44-48) L/XL (50-54) XXL/XXXL (56-60)	
N	KE0-3029-A01	55,00	C KS Top LS: Karting long sleeved underwear top made in lightweight, insulating and breathable fabrics. The 3D structure allows a quick sweat expulsion keeping the body dry in stress condition. Made with Dryarn®, an high performance fiber very appreciated in all sport competitions that give comfort in every condition thanks to the innovative construction.	White (KE0-3029-A01-020-XXX)	XS-S (44-48) M-L (50-54) XL-XXL (56-60) 8/10 years 10/12 years	
N	KE0-3030-A01	48,00	C KS Top SS: Karting short sleeved underwear top made in lightweight, insulating and breathable fabrics. The 3D structure allows a quick sweat expulsion keeping the body dry in stress condition. Made with Dryarn®, an high performance fiber very appreciated in all sport competitions that give comfort in every condition thanks to the innovative construction.	White (KE0-3030-A01-020-XXX)	XS-S (44-48) M-L (50-54) XL-XXL (56-60) 8/10 years 10/12 years	
	KE0-3026-A01	22,00	C Disposable balaclava in TNT allergenic material. Sold in packages of 25 pieces individually packed.	White (KE0-3026-A01)	One Size	

R	Ref	Euro	Description	Colour	Size	Homolog.
N	KE0-3028-A01	22,00	C KS Balaclava: Karting balaclava made in lightweight, insulating and breathable fabrics. The 3D structure allows a quick sweat expulsion keeping the garment dry in stress condition. Made with Dryarn®, an high performance fiber very appreciated in all sport competitions that give comfort in every condition thanks to the innovative construction.	White (KE0-3028-A01-020) Black (KE0-3028-A01-071)	One Size	
N	KE0-3028-AK1	22,00	C KS Balaclava Kids: Karting balaclava made in lightweight, insulating and breathable fabrics. The 3D structure allows a quick sweat expulsion keeping the garment dry in stress condition. Made with Dryarn®, an high performance fiber very appreciated in all sport competitions that give comfort in every condition thanks to the innovative construction.	White (KE0-3028-AK1-020) Black (KE0-3028-AK1-071)	One Size	
N	KE0-3031-A01	22,00	C KS Shorts: Karting underwear shorts pants made in lightweight, insulating and breathable fabrics. The 3D structure allows a quick sweat expulsion keeping the body dry in stress condition. Made with Dryarn®, an high performance fiber very appreciated in all sport competitions that give comfort in every condition thanks to the innovative construction.	White (KE0-3031-A01-020-XXX)	XS-S (44-48) M-L (50-54) XL-XXL (56-60) 8/10 years 10/12 years	
	KE0-3019-A01	15,50	C KS Socks: Technical socks with elastic fabric and differentiated weave reducing the feeling of fatigue of the legs while driving. Short lenght.	White (KE0-3019-A01-020X)	S-M-L	
NV	KE0-3027-A01	7,50	C Balaclava in polyester and spandex fabric.	White (KE0-3027-A01-020) Black (KE0-3027-A01-071) Blue (KE0-3027-A01-041) Red (KE0-3027-A01-061) Fluo yellow (KE0-3027-A01-099)	One Size	
KARTWEAR ACCESSORIES						
	KK0-3106-A01	69,00	C Rain-K Suit - Adult: Waterproof kart oversuit made in ultrathin (0.15 mm), lightweight and resistant transparent material. Heat welded taped seams, waterproof central zipper with inner V shaped gusset to protect against heavy rain. Comfortable stretch band on waist and elastic bellows on wrist to get the best comfort. Adjustable ankle closure with zipper and velcro allows you to fit quickly the suit. High resistance nylon insert on right elbow. Available for adults (KK0-3106-A01) and for children (KK0-3106-AK1).	Transparent (KK0-3106-A01-004-XXX)	XS (42) S (44-46) M (48-50) L (52-54) XL (56-58) XXL (60-62)	
	KK0-3107-A01	63,00	C KS Raincoat: Raincoat made in ultrathin, lightweight and resistant transparent material. Heat welded taped seams, buttons closure, adjustable hoodie with string. Two large pockets. Suitable for mechanics and paddock operators.	Transparent (KK0-3107-A01-004-XXX)	S-M-L-XL	
	KK0-3106-AK1	59,00	C Rain-K Suit - Kids: Waterproof kart oversuit made in ultrathin (0.15 mm), lightweight and resistant transparent material. Heat welded taped seams, waterproof central zipper with inner V shaped gusset to protect against heavy rain. Comfortable stretch band on waist and elastic bellows on wrist to get the best comfort. Adjustable ankle closure with zipper and velcro allows you to fit quickly the suit. High resistance nylon insert on right elbow. Available for adults (KK0-3106-A01) and for kids (KK0-3106-AK1).	Transparent (KK0-3106-AK1-004-XXX)	120÷160 (height in cm)	
	KK0-4003	54,00	C Collar created in expanded polyurethane with differentiated density, stiff in the rear part, soft in the front part in order to allow forward movements of the head. Cordura covering, the part in contact with the neck is in a soft-knitted fabric material.	Black (KK0-4003-071)	One Size	F de K 1997
	KK0-4009	45,00	C Waterproof kart neck collar, modern K-STYLE design.	Grey (KK0-4009-080)	One size	
	KK0-0008	29,00	C Rainproof shoe-cover. Fabric in nylon. Seams heat welded. Sole ultra soft reinforced rubber.	Black (KK0-0008-071-XX)	XS (32÷34) S (35÷38) M (39÷41) L (42÷44) XL (45÷47)	
	KK0-4005	20,00	C Padded knee pads.	Black (KK0-4005-071)	One Size	
	KK0-4006	20,00	C Padded elbow pads.	Black (KK0-4006-071)	One Size	

KART VESTS

R	Ref	Euro	Description	Colour	Size	Homolog.	
	KKO-0049-B01	315,00	C	<p>KS-1 PRO Body Protection: FIA homologated karting body protection. Outside in resistant polycarbonate material, inner lining in nitrile rubber and shockproof memory foam that dissipates energy in case of accident. KS-1 PRO offers complete protection to the driver (ribs, front and back) combined with maximum comfort thanks to the internal padding and the exclusive auto-adjustable fitting system. Adjustable shoulder and lateral straps with velcro, shaped front shield to get best comfort and higher protection.</p> <p>AVAILABLE UNTIL STOCK LAST</p> <p>KS-1 PRO can accommodate various heights and body shapes thanks to seven different sizes: four standard-fit sizes (S-M-L-XL) and 3 wide-fit sizes (M wide, L wide, XL wide). The spare inner padding kit (6mm thicker) guarantees a perfect fit also to skinniest bodies without compromising comfort and safety (available as optional sold separately, easy to set up thanks to velcro quick attachments - part n° KK049/PAD).</p> <p>Sizes: S (homologated from 116 to 152 cm height - suggested for 63-71 cm chest circumference) M (homologated from 152 to 170 - suggested for 69,5-80 cm chest circumference) M wide (homologated from 152 to 170 - suggested for 79,5-90 cm chest circumference) L (homologated from 170 to 188 - suggested for 77-90 cm chest circumference) L wide (homologated from 170 to 188 - suggested for 78-100 cm chest circumference) XL (homologated from 188 - suggested for 90-105 cm chest circumference) XL wide (homologated from 188 - suggested for 105-120 cm chest circumference)</p>	<p>Black/fluo yellow (KKO-0049-B01-178-XX)</p>	<p>S M M Wide L L Wide XL XL Wide</p>	FIA 8870-2018
	KKO-0048-A01	139,00	C	<p>PRO Rib Vest: Lightweight and resistant rib vest in polycarbonate material. Provides comfort to the ribs and back, with adjustable straps to improve fitting.</p>	<p>Fluo yellow (KKO-0048-A01-178-XX) Black (KKO-0048-A01-071-XX)</p>	<p>XS-S M-L</p>	
	KKO-0047-B01	103,00	C	<p>Carbon Rib Vest: Carbon fiber rib vest with adjustable buckles for karting. K-STYLE design.</p>	<p>Black (KKO-0047-B01-007-XX)</p>	<p>XS=L</p>	
	KKO-4001	50,50	C	<p>Rib Vest: Rib vest, made in shockproof fabric with stretching fabric cover. Double closing on chest with micro-metrical regulation.</p>	<p>Black (KKO-4001-071-XX) Red (KKO-4001-061-XX) Blue (KKO-4001-041-XX)</p>	<p>XS=L</p>	
	KKO-0049-A02	35,00	C	<p>Size adjuster kit in expanded polyethylene for KS-1 PRO. Includes two flanks and one back part. 6mm thick. Inner fabric in washable Lycra, external side with velcro for attachment to the antishock layer of KS-1 PRO. This adjuster kit can replace the standard kit (3 mm) to increase comfort whenever the strap adjusters are not enough to guarantee the best adhesion to the body.</p>		<p>S M M Wide L L Wide XL XL Wide</p>	

GLOVES

Descriptive List

R	Ref	Euro		Description	Colour	Size	Homolog
FIRE RETARDANT RACING GLOVES							
NV	IBO-0773-A01	199,00	C	ONE EVO FX Gloves: High safety top level FIA 8856-2018 gloves with back in breathable honeycomb fabric and palm in silicon rubber. External seams for maximum feeling on steering wheel, elastic wrist stop to get best comfort. COMPLIANT WITH LATEST FIA GLOVE'S HOMOLOGATION REQUIREMENTS THAT INTRODUCES A NEW LEVEL OF SAFETY NEW COLOR RANGE IN STOCK	Navy blue/cyan (IBO-0773-A01-244-XX) Black (IBO-0773-A01-071-XX) Fluo yellow (IBO-0773-A01-099-XX) White (IBO-0773-A01-020-XX) Red (IBO-0773-A01-061-XX)	XS+XL	FIA 8856-2018 LATEST UPDATE
N	IBO-0775-A01	176,00	C	ONE EVO X Gloves my2024: Top level lightweight precurved gloves. Upper made in breathable honeycomb fabric, exclusive high technology palm in silicon rubber proven to give optimal grip, lightness and sensitivity. External seams for maximum feeling on steering wheel, elastic wrist stop to get maximum fitting comfort. COMPLIANT WITH LATEST FIA GLOVE'S HOMOLOGATION REQUIREMENTS THAT INTRODUCES A NEW LEVEL OF SAFETY	Black (IBO-0775-A01-071-XX) Red (IBO-0775-A01-061-XX) Navy blue/cyan (IBO-0775-A01-244-XX) White (IBO-0775-A01-020-XX) Fluo yellow (IBO-0775-A01-099-XX)	XS+XL	FIA 8856-2018 LATEST UPDATE
	IBO-0763-B01		C	ONE ART Gloves: Top level racing gloves with totally printable design. Fire retard silicon rubber palm for maximum grip and external seams fo best sensitivity. Precurved, slanted cut wrist. AVAILABLE ONLY UPON REQUEST FIA 8856-2018 HOMOLOGATION	Custom	XS+XL	FIA 8856-2018
	IBO-0770-A01	143,00	C	ONE-S Gloves: Fire retardant precurved top level gloves. Diagonal cuts, elastic band on the wrist. Inserts for better wearing. External seams for maximum comfort, fire retardant antislip silicon rubber palm.	Black (IBO-0770-A01-071-XX) White (IBO-0770-A01-020-XX) Red (IBO-0770-A01-061-XX) Fluo yellow (IBO-0770-A01-099-XX) Navy blue/orange (IBO-0770-A01-249-XX)	XS-XXL	FIA 8856-2018 SFI 3.3 on request
	IBO-0772-A01	130,00	C	TECNICA Gloves: High adherence racing gloves. Palm in suede leather with silicon rubber inserts, external seams, adjustable velcro strap closure for snug fitting at the wrist. Slanted cut and elastic wrist stop. Fresh design.	Red (IBO-0772-A01-061-XX) White (IBO-0772-A01-020-XX) Navy blue/navy (IBO-0772-A01-244-XX) Black/fluo yellow (IBO-0772-A01-178-XX) Black/white (IBO-0772-A01-076-XX) Black/red (IBO-0772-A01-073-XX)	XS+XL	FIA 8856-2018
N	IBO-0776-A01	82,00	C	FIRST Gloves: Lightweight and resistant glove with elastic band on the wrist, straight cutted design. Silicon palm for best grip and sensitivity. External seams.	Navy blue (IBO-0776-A01-042-XX) Red (IBO-0776-A01-061-XX) Black (IBO-0776-A01-071-XX) Navy blue/tiffany (IBO-0776-A01-248-XX) Black/fuchsia (IBO-0776-A01-277-XX)	S-XL	FIA 8856-2018
N	IBO-0777-A01	74,00	C	SPORT Gloves: Fire retardant comfortable and resistant racing gloves with silicon rubber palm and internal seams. Excellent quality/price ratio. Elastic wristband.	Black/white (IBO-0777-A01-076-XX) Black/red (IBO-0777-A01-073-XX) Black/fluo yellow (IBO-0777-A01-178-XX) Navy blue/cyan (IBO-0777-A01-244-XX)	XS-XL	FIA 8856-2018
	IBO-0702-A01	67,00	C	New Rally Gloves: Glove made of stretch fire resistant, with palm in suede leather. Good quality, ideal for use in harsh conditions. Elastic wrist stop.	Red (IBO-0702-A01-061-XX) Blue (IBO-0702-A01-041-XX) Black (IBO-0702-A01-071-XX)	S+XL	ISO 6940
VINTAGE GLOVES							
	IBO-0746-B01	123,00	C	Dijon Gloves: Vintage design glove. Made in fire retardant elastic fabric. Palm in suede leather, internal seams. Elastic wrist stop.	Cream with brown stripes (IBO-0746-B01-010-XX) Blue with white and orange stripes (IBO-0746-B01-041-XX)	S+XL	FIA 8856-2018

R	Ref	Euro	Description	Colour	Size	Homolog
	IB0-0747-A01	41,00	C Tazio Gloves: Driving glove with vintage design, made with smooth leather and fishnet fabric. Strap with velcro.	Cream/brown (IB0-0747-A01-010-XX) Black/grey (IB0-0747-A01-071-XX)	S÷XL	
KART GLOVES						
	KB0-2746-A01		C KS ART Gloves: Top level kart gloves with totally printable design. Made of stretch fabric, precurved, with silicon rubber palm for maximum grip and external seams for best sensitivity. Elastic band on wrist for best fitting. Slanted cut wrist. AVAILABLE ONLY UPON REQUEST.	Custom	XS÷XL Taglie 4-5-6 da bimbo/ XXS÷XL Sizes 4-6 for kids	
N	KB0-2751-A01	115,00	C KS-X Gloves: Top level karting gloves made in stretch fabric. Precurved silicon rubber palm with antislip silicon points for maximum grip. External seams for maximum sensitivity. Elastic band on wrist for best fitting. FIA 8877-2022 HOMOLOGATION.	Black (KB0-2751-A01-071-XX) White (KB0-2751-A01-020-XX) Fiuo yellow (KB0-2751-A01-099-XX)	XXS÷XL Taglie 4-5-6 da bimbo/ XXS÷XL Sizes 4-6 for kids	FIA 8877-2022
	KB0-2745-A01	109,00	C Advanced RainProof (ARP) Gloves: Rainproof kart gloves in stretch fabric, precurved, with high grip silicon rubber palm. Water-repellent treatment with waterproof membrane to protect hands against rain and bad weather. External seams for maximum sensibility, slanted cut on wrist, elastic wrist stop to guarantee the best fitting.	Black (KB0-2745-A01-071-XX)	XXS÷XXL	
	KB0-2749-A01	67,00	C KS-2R Gloves: Karting gloves with external seams and silicon rubber palm for maximum grip. Bellows on knuckles and fingers for best freedom of movement and breathable inserts in mesh fabric to increase comfort. Silicon rubber protection on fingers, slanted wrist cut with elastic band. Fresh design and wide color range thanks to silkscreen printing technology mixed with sublimation prints.	Black (KB0-2749-A01-071-XX) Red/black (KB0-2749-A01-060-XX) Yellow/black (KB0-2749-A01-059-XX) White/red/black (KB0-2749-A01-120-XX) Navy blue/white/cyan (KB0-2749-A01-242-XX)	XXS÷XL Taglie 4-5-6 da bimbo/ XXS÷XL Sizes 4-6 for kids	
	KB0-2743-B01	47,00	C KS-3 Gloves: Kart gloves made of resistant and comfortable stretch fabric. Synthetic leather palm with silicon rubber inserts for the best grip. Elastic wrist stop to increase comfort and rubber protection on knuckles.	Black/white (KB0-2743-B01-076-XX) Black/blue/white (KB0-2743-B01-175-XX) Black/red (KB0-2743-B01-060-XX) Black/fiuo yellow (KB0-2743-B01-059-XX) Black/fiuo orange (KB0-2743-B01-096-XX)	XXS÷XL Taglie 4-5-6 da bimbo/ XXS÷XL Sizes 4-6 for kids	
	KB0-2739-A01	43,00	C RAIN K Gloves: Neoprene karting gloves water and wind resistant. Palm made of neoprene with anti-slippery rubber inserts. Elastic wrist stop. White design on the back.	Black (KB0-2739-A01-071-XX)	XXS÷XL Taglie 4-5 da bimbo/ XXS÷XL Sizes 4-5 for kids	
	KB0-2748-A01	41,00	C KS-2 ART Gloves: Kart gloves with printed graphic. Stretch polyester lightweight fabric and silicon rubber palm for best grip. Elastic band on wrist to improve fitting. External seams and thin palm material for maximum feeling on steering wheel. Modern design available in several colors.	White/black (KB0-2748-A01-076-XX) Black/fiuo yellow (KB0-2748-A01-178-XX) Black/fiuo green (KB0-2748-A01-274-XX) Black/fiuo orange (KB0-2748-A01-179-XX) Black/cyan (KB0-2748-A01-275-XX) Black/red (KB0-2748-A01-073-XX)	XXS-XL (4-5-6 per bambini / for children)	
	KB0-2750-A01	38,00	C KS-4 Gloves: Entry level karting gloves with suede leather palm. Modern design thanks to the silicon rubber printed design on back. Internal seams and elastic wrist stop to improve fitting.	Black (KB0-2750-A01-071-XX) Blue/white (KB0-2750-A01-043-XX) Red/white (KB0-2750-A01-063-XX) Yellow/black (KB0-2750-A01-059-XX) Green/white (KB0-2750-A01-231-XX) Mint green (KB0-2750-A01-233-XX)	XXS÷XL Taglie 4-5-6 da bimbo/ XXS÷XL Sizes 4-6 for kids	
MECHANICS' GLOVES						
	IB0-0758-B01	146,00	C PRO Mech EVO Gloves: Fire retardant mechanic's gloves, offering excellent protection against heat and impacts. Reinforcements in high protective silicon rubber sheet with perforated soft upper	Black (IB0-0758-B01-071-XX)	S÷XL	FIA 8856-2018

R	Ref	Euro	Description	Colour	Size	Homolog
	IB0-0758-C01	146,00	C PRO Mech-S Gloves: Fire retardant mechanic's gloves, offering excellent protection against heat and impacts. Reinforcements in high protective silicon rubber sheet with perforated soft upper fabric located in critical impact areas (knuckles, between thumb and forefinger. Inner seams, anti-slip silicon rubber palm and fingers. This glove differs from the standard PRO Mech EVO IB0-0758-B01 for the classic cuff with no padded protection. This feature makes the gloves more comfortable for certain operations that require more accuracy (fuel refilling, for instance).	Fluo yellow (IB0-0758-C01-178-XX)	S=XL	FIA 8856-2018
	NB0-1896-A01	26,00	C Workshop EVO Gloves: Technical short gloves. Back in technical elastic fabric with leather inserts and silicon rubber design, palm in suede leather to get the best accuracy and adherence. Elastic band on wrist and adjustable velcro closure with rubber strap for great comfort.	Black (NB0-1896-A01-071-XX)	S=XXL	
	NB0-1885	18,00	C Technical glove in polyester/coton, palm and fingers with PVC rubber dots, elastic slipout-proof cuffs.	Dark grey (NB0-1885-080-XX)	M=L	

R	Ref	Euro		Description	Colour	Size	Homolog
FIRE RESISTANT RACING BOOTS							
	IC0-0805-B01	373,00	C	ONE EVO X R Shoes: Professional top level racing boot in ultra-soft leather and fabric with micro adjustment ROTOR LACING that ensures an easy and quick lacing and a perfect fitting. Very lightweight and comfortable structure designed to increase the sensitivity on the pedal. High resistance and best grip. The perforated leather guarantees best breathability. Rear bellow to increase comfort. Modern design featured by a wide color range.	Black (IC0-0805-B01-071-XX) Fluo yellow (IC0-0805-B01-099-XX) White (IC0-0805-B01-020-XX) Black/silver/fluo yellow (IC0-0805-B01-370-XX) Navy blue/silver/cyan (IC0-0805-B01-246-XX) Black/silver/red (IC0-0805-B01-172-XX)	37÷48	FIA 8856-2018
NV	IC0-0831-A01	315,00	C	ONE EVO FX Shoes: The FIA-homologated and ultralightweight ONE EVO FX is the highest-level OMP racing shoe, specifically developed for professional drivers' needs, relying on Formula 1 experience. The ONE EVO FX upper is made by fireproof Nomex fabric to combine lightness, comfort and breathability, with silicone reinforcements on tip and back to prevent wear, even after the most intense usage. The honeycomb internal layers offer the maximum perspiration, also during the hottest races and inside closed cockpits. The 100% natural rubber outer sole and heel features two different surface treatments. The front embossing provides the driver the best responsiveness on the market when mastering the pedals, while the rear pattern provides the necessary grip. The insole is designed to ensure the optimal foot sensitiveness.	Black (IC0-0831-A01-071-XX)	37÷48	FIA 8856-2018
N	IC0-0833-A01	290,00	C	ONE EVO X Shoes my2024: Top level shoes FIA 8856-2018 made in ultrasoft leather and fabric inserts. High resistant new generation two-tone outsole sole for maximum grip. Velcro strap for best fitting. Structure designed to increase the sensitivity on the pedal, thin laces for high sliding and a quick lacing of the boots, rear bellow for maximum freedom of movement.	Black (IC0-0833-A01-071-XX) White (IC0-0833-A01-020-XX) Red (IC0-0833-A01-061-XX) Fluo yellow (IC0-0833-A01-099-XX) Navy blue/cyan (IC0-0833-A01-244-XX)	36÷48	FIA 8856-2018
	IC0-0819-B01		C	ONE ART Shoes: High level professional race boots with totally printable design. Made with one piece of soft fire retardant fabric, no-laces, elastic fit with adjustable velcro strap to give the best comfort. High resistant side protection on tip. On request: it is possible to customize the shoes by adding/removing the inner foot support to get more comfort/sensibility. Unlimited customization ways thanks to the totally printed design. AVAILABLE ONLY UPON REQUEST.	Custom	37÷48	FIA 8856-2018
	IC0-0822-A01	245,00	C	ONE-S Shoes: Top level leather boot, technical reinforcements on the tip and on the heel. Injected high resistant sole and best grip. Velcro strap for a best fitting of the ankle. Inner sole with plate reinforcement for highest sensitivity and reduction of the stress on the feet. Thin laces for high sliding and a quick lacing of the boots. Modern design.	Black (IC0-0822-A01-071-XX) White (IC0-0822-A01-020-XX) Fluo yellow (IC0-0822-A01-099-XX) Navy blue/orange (IC0-0822-A01-249-XX) Red (IC0-0822-A01-061-XX)	37÷48	FIA 8856-2018 SFI 3.3 on request
	IC0-0823-A01	213,00	C	TECNICA Shoes: Soft and comfortable high quality leather shoes. Outer side made in soft suede leather and internal side in resistant smooth leather. Ultralight outsole construction for direct pedal feeling and improved foot protection. Reinforcement on tip and comfortable rear bellow. Modern two-tone design.	Black/red (IC0-0823-A01-073-XX) Black/fluo yellow (IC0-0823-A01-178-XX) Black/anthracite (IC0-0823-A01-077-XX) Navy blue/cyan (IC0-0823-A01-242-XX)	37÷48	FIA 8856-2018
	IC0-0828-A01	189,00	C	ONE TT Shoes: "Tout Terrain" shoes suitable for co-drivers and pit crew made in leather with EVA rubber sole. The innovative antislip outsole "Three Direction Grip" guarantees maximum grip on every condition also on uneven surfaces (mud, snow) thanks to outdoor inspired features and located rubber cleats. Suitable for indoor use as well, this boot is the result of cooperation with Williams F1 team pit crew. The high stability heel with anti abrasion protection, adjustable velcro's strap on ankle, breathable material areas and the rear bellow makes the shoes comfortable and durable.	Black (IC0-0828-A01-071-XX)	37÷48	FIA 8856-2018

R	Ref	Euro	Description	Colour	Size	Homolog
	IC0-0824-A01	140,00	C FIRST Shoes: Race boots made of suede leather with an excellent quality/price ratio. New lightweight and resistant antislip sole with a round cutted heel in order to ease the rotation of the feet while driving. Velcro strap on the ankle for best fitting, inner black knitted fabric. Reinforcements on the tip. NEW COLOR RANGE	Black/white (IC0-0824-A01-071-XX) Black/red (IC0-0824-A01-073-XX) Anthracite/fluo yellow (IC0-0824-A01-182-XX) Navy blue/cyan (IC0-0824-A01-242-XX) Navy blue/orange (IC0-0824-A01-249-XX) Navy blue/tiffany (IC0-0824-A01-248-XX) Black/fuchsia (IC0-0824-A01-277-XX)	37÷48	FIA 8856-2018 SFI 3.3 on request
NV	IC0-0829-A01	116,00	C OMP Sport Shoes: Entry level race boots made in soft, comfortable and lightweight microfiber. Exclusive resistant antislip rubber sole inspired by car's tyres (high grip in every condition and long-time resistance). Shaped ankle with rear bellow to increase comfort and ease the movement. The silkscreen printing technology gives the boots an innovative design. NEW COLORS	Black/white (IC0-0829-A01-071-XX) Black/red (IC0-0829-A01-073-XX) Black/fluo yellow (IC0-0829-A01-178-XX) Black/cyan (IC0-0829-A01-275-XX)	36÷47	FIA 8856-2018
VINTAGE BOOTS						
	IC0-0784-B01	255,00	C Carrera Shoes: Mid cut vintage design boot made of high quality treated leather for an ultrasoft feeling. Contrasting inserts, laced closure, with a handcrafted rubber sole hydrocarbons resistant. Embossed leather logo.	Brown (IC0-0784-B01-015-XX) Dark brown (IC0-0784-B01-014-XX) Black (IC0-0784-B01-079-XX)	37÷48	FIA 8856-2018
KART BOOTS						
	KC0-0818-A01		KS ART Shoes: High level professional kart boots with totally printable design. Made with one piece of soft fabric, no-laces elastic fit to give the best comfort. Adjustable velcro strap with inward closure studied to avoid to accidentally get stucked on gas cable. On request: it is possible to customize the shoes by adding/removing the inner foot support to get more comfort/sensibility. Unlimited customization ways thanks to the totally printed design. AVAILABLE ONLY UPON REQUEST.	Custom	32÷48	
N	KC0-0834-A01	225,00	C KS-X R Shoes: Top level kart boots with exclusive rotor lacing inspired on the ONE EVO X R racing boots, new generation sole which guarantees highest sensitivity and grip. Made of very lightweight perforated microfiber that guarantees the best breathability, with technical protection on the tip. Rear bellow to increase comfort. FIA 8877-2022 HOMOLOGATION.	Black (KC0-0834-A01-071-XX) Anthracite/silver/yellow (KC0-0834-A01-370-XX)	32÷48	FIA 8877-2022
N	KC0-0835-A01	199,00	C ARP-X Shoes: High-height karting boots in polyurethane with waterproof membrane under the laces and high height ankle to protect feet against rain and bad weather. Adjustable double strap with velcro closure and rear bellow to increase comfort and freedom of movement. High resistance side protection on tip. The high-grip injected sole and the light weight make the boots perfect for driving in all weather conditions, not only while raining. FIA 8877-2022 HOMOLOGATION.	Black (KC0-0835-A01-071-XX)	34÷48	FIA 8877-2022
	KC0-0815-A01	135,00	C KS-1 Shoes: Top level karting shoes, derived directly from F1&WRC racing shoes. Realized in polyurethane, with ultralight outsole specifically designed for karting that guarantees the highest sensitivity when driving. Rear inserts in elastic padded material for improved comfort, separate ankle adjustment with velcro strap, pivot heel design for smooth actuation. Large areas in mesh fabric for best breathability.	White/black/red (KC0-0815-A01-120-XX) Black/white/grey (KC0-0815-A01-070-XX) Fluo yellow/fluo green (KC0-0815-A01-058-XX) Navy blue/white/cyan (KC0-0815-A01-244-XX)	32÷48	
	KC0-0830-A01	109,00	C KS-2F Shoes: Karting shoes in polyurethane with outsole specifically designed for kart driving. Ankle socks in stretch fabric for best freedom of movement, laces with puller to make the fitting faster and comfortable. Technical reinforcements on tip and heel, perforated material on side to guarantee best ventilation.	White (KC0-0830-A01-020-XX) Red/black (KC0-0830-A01-060-XX) Black (KC0-0830-A01-071-XX) Black/fluo yellow (KC0-0830-A01-178-XX) Navy blue/cyan (KC0-0830-A01-244-XX)	32÷47	
	KC0-0825-A01	99,00	C KS-2 Shoes: Karting shoes in microfiber. Outsole specifically designed for kart driving, rear insert in elastic padded material for improved comfort, separate ankle adjustment with velcro strap "pull for fit". Technical reinforcements on tip and heel. Modern and fresh design, lace-free fitting with elastic inserts.	Black (KC0-0825-A01-071-XX) Red/black (KC0-0825-A01-060-XX) White (KC0-0825-A01-020-XX) Yellow/black (KC0-0825-A01-059-XX)	32÷47	

R	Ref	Euro	Description	Colour	Size	Homolog
	KC0-0826-A01	85,00	C KS-3 Shoes: Karting shoes in suede leather with mesh inserts for high breathability. Outsole specifically designed for kart drivers, rear insert in elastic padded material for improved comfort. Technical reinforcements on tip and hell. Modern and fresh design.	Black (KC0-0826-A01-071-XX) Red (KC0-0826-A01-060-XX) Black/white (KC0-0826-A01-076-XX) Black/fluo yellow (KC0-0826-A01-178-XX) Black/red (KC0-0826-A01-073-XX) Blue/cyan (KC0-0826-A01-244-XX)	32÷47	

HELMETS

Descriptive List

R	Ref	Euro		Description	Colour	Size	Shell	Homol.
RACING HELMETS								
	SC0-0799-B01	399,00	C	GP-R Helmet: Full face helmet in composite material. Lightweight shell, high ventilation thanks to four air intakes on chin and eight vents on top. The standard sized eyeport allows to use the helmet with both classic shields and touring sun peak (sold separately - SC179) and makes the helmet suitable for several motorsports disciplines, from formula cars to GT cars. Soft inner comfortable fabrics allows best fitting comfort; double ring closure. Hans posts fitted. Spare parts: Clear visor SC195, Dark visor SC196, Iridium visor SC197, Pivot kit SC194	White (SC0-0799-B01-020-XX)	XXS=XL	2	FIA 8859-2015
	SC0-0801-A01	319,00	C	J-Rally Helmet: Open face racing helmet. High quality lightweight composite material shell, high breathability fire retardant internal lining. Complete with an anti dazzle peak fitted with a tinted visor strip. With Hans posts fitted. Pre-installed ZeroNoise intercom kit (ultra-thin loudspeaker integrated and adjustable microphone boom) with female Nexus plug.	White (SC0-0801-A01-020-XX)	S=XL	2	FIA 8859-2015
KART HELMETS								
	SC0-0799-B02	365,00	C	GP-R K Helmet: Full face karting helmet in composite material. Lightweight shell, high ventilation thanks to four air intakes on chin and eight vents on top. Standard size eyeport, soft inner comfortable fabrics that allows best fitting comfort; double ring closure. Spare parts: Clear visor SC195, Dark visor SC196, Iridium visor SC197, Pivot kit SC194	White (SC0-0799-B02-020-XX)	XXS=XL	2	SNELL-K 2020
	SC0-0790-B01	340,00	C	KJ-8 EVO: Full face karting CMR helmet made in composite material. Lightweight, with soft and comfortable high breathability internal lining, bordered strap with double ring closure and high precision adjustable visor with easy block system. The air vents and intakes ensure the best air ducting. Spare iridium blue visor included in the box.	White (SC0-0790-B01-020-XX)	XS=L	1	CMR 2016
ECE HELMETS								
N	SC0-0617-A02	189,00	C	STAR-J INTERCOM: Open face helmet with ABS shell, velvet lining not fire retardant, revomable peak. Micrometric quick release padded strap. Pre installed club intercom kit (ultra-thin loudspeaker integrated and adjustable microphone boom) with stereo plug. Also available without pre installed intercom kit (SC0-0617-A01) ECE 22.06 HOMOLOGATION.	White (SC0-0617-A02-020-XX) Matt black (SC0-0617-A02-170-XX) Fluo yellow (SC0-0617-A02-099-XX)	S=XXL	1	ECE 22.06
N	SC0-0616-A01	109,00	C	Circuit EVO2: Full face thermoplastic helmet with breathable and comfortable lining (not fire retardant), removable cheek pads, chin curtain and removable breath guard. Micrometric quick release padded strap, anti scratch step setting visor. Aerodynamic lines, adjustable air vents. Available in classic colors or in modern bright fluo yellow. ECE 22.06 HOMOLOGATED.	White (SC0-0616-A01-020-XX) Matt black (SC0-0616-A01-170-XX) Fluo yellow (SC0-0616-A01-099-XX)	XS=XXL	1	ECE 22.06
N	SC0-0617-A01	89,00	C	STAR ECE 22.06: Open face helmet with ABS shell, velvet lining not fire retardant, revomable peak. Micrometric quick release padded strap. Also available with preinstalled club stereo intercom (SC0-0617-A02) ECE 22.06 HOMOLOGATED	White (SC0-0617-A01-020-XX) Matt black (SC0-0617-A01-170-XX) Fluo yellow (SC0-0617-A01-099-XX)	S=XXL	1	ECE 22.06
	SC0-0607-B01	65,00	C	STAR ECE 22.05: Open face helmet with ABS shell, velvet lining not fire retardant, revomable peak. Micrometric quick release padded strap. ECE 22.05 HOMOLOGATED AVAILABLE UNTIL STOCK LAST	White (SC0-0607-B01-020-XX) Matt black (SC0-0607-B01-170-XX) Fluo Yellow (SC0-0607-B01-099-XX)	S=XXL	1	ECE 22.05
HELMET'S ACCESSORIES								
GP-R & GP-R K (SC0-0799-XX)								
	SC0-0197	88,00	C	Rainbow visor	Rainbow (SC0-197)			
	SC0-0196	71,00	C	Smoked visor	Dark (SC0-196)			
	SC0-0195	63,00	C	Clear visor	Clear (SC0-195)			
	SC0-0179	42,00	C	White sun peak	White (SC0-179020)			
	SC0-0194	25,00	C	Pivot kit				
	SC0-179071	24,00	C	Black sun peak	Black (SC0-179071)			
	SC0-0181	16,50	C	Fixing screw kit for peak				
	SC0-0180	12,70	C	Spare sun lens for peak				
J-R (SC0-0795-A01 / SC0-0796-A01 / SC0-0797-A01 / SC0-0798-A01) - J-RALLY (SC0-0801-A01)								

Remark

N = New

NV = Variation

R	Ref	Euro	Description	Colour	Size	Shell	Homol.	
	SC0-0182	79,00	C Cheek pads sizes: S-XL					
	SC0-0179	42,00	C White sun peak	White (SC0-179020)				
	SC0-179071	24,00	C Black sun peak	Black (SC0-179071)				
	SC0-0181	16,50	C Fixing screw kit for peak					
	SC0-0180	12,70	C Spare sun lens for peak					
STAR (SC0-607XX / SC0-617XX)								
	SC0-0153	11,60	C Black sun peak visor	Black (SC0-153)				
	SC0-0178	11,60	C White sun peak visor	White (SC0-178)				
	JA0-854		Microphone kit with microphone boom for open face helmet. Male Stereo connector.					
CIRCUIT EVO (SC0-0613-A01)								
	SC0-0185	18,50	C Clear visor					
	SC0-0186	18,50	C Dark visor					
	SC0-0187	8,40	C Spare front air vents					
	SC0-0188	8,40	C Spare rear air vents					
	SC0-0189	8,40	C Spare chin air vent					
	SC0-0190	8,40	C Spare visor movement pivot kit					
CIRCUIT EVO2 (SC0-0616-A01)								
N	SC0-0198	19,00	C Clear visor					
N	SC0-0199	19,00	C Dark visor					
N	SC0-0200	8,40	C Visor pivot kit					
N	SC0-0201	8,00	C Spare top air vents					
N	SC0-0202	8,00	C Spare chin air vent					

ZERO NOISE COMMUNICATION DEVICES

Descriptive List

R	Ref	Euro	Description
ZERO NOISE COMMUNICATION DEVICES			
INTERCOM AMPLIFIERS			
N	6100041	800,00	Z FEARLESS WW: Revolutionary Zeronoise amplifier that combines wired and wireless communication using the same adaptive noise cancelling algorithm. This ensures a smooth transition between wired and wireless mode as the intercom automatically switches to the most efficient way to manage the communication between driver and co-driver, inside and outside the car. The amplifier display shows all relevant information: battery level, connection status, sound settings and more. It works wirelessly with selected models of Bell Rally helmets, but it is fully compatible with any helmet in the market that features a standard Nexus connector. The military grade technology on which Fearless Wireless is based on, makes sure all communications are encrypted, reliable, and able to work in any environment.
	6100036	1.150,00	Z AMPLIFIER FEARLESS WRC CanBus: Fearless WRC CanBus is a professional digital amplifier with an integrated digital back-up unit and CanBus connectivity for a full car integration. Through the Can-Bus it is possible to set every parameter of the amplifier from the car and visualise the values directly on the car display in the dashboard. The amplifier has Deutsch connectors. Available upon request.
	6100026	510,00	Z PIT-LINK BLUETOOTH: Bluetooth Digital Amplifier that allows professional communication between two people in the car and the pit at the same time through Bluetooth smartphone connection. Noise and voice can be digitally set to fine tune noise canceling and voice. Communication can open up automatically or via PTT button. Digital Noise Filters and Voice Equalisation, Multifunction Touch Display, Nexus connectors, L=2m cables, Car Camera Audio output (RCA), Car battery cable 12V. Software updates through USB-C port, black rugged cover. Male 4 PIN Nexus
	6100027	510,00	Z PIT-LINK BLUETOOTH: Bluetooth Digital Amplifier that allows professional communication between two people in the car and the pit at the same time through Bluetooth smartphone connection. Noise and voice can be digitally set to fine tune noise canceling and voice. Communication can open up automatically or via PTT button. Digital Noise Filters and Voice Equalisation, Multifunction Touch Display, Nexus connectors, L=2m cables, Car Camera Audio output (RCA), Car battery cable 12V. Software updates through USB-C port, black rugged cover. Female 4 PIN Nexus
	6100028	510,00	Z PIT-LINK BLUETOOTH: Bluetooth Digital Amplifier that allows professional communication between two people in the car and the pit at the same time through Bluetooth smartphone connection. Noise and voice can be digitally set to fine tune noise canceling and voice. Communication can open up automatically or via PTT button. Digital Noise Filters and Voice Equalisation, Multifunction Touch Display, Nexus connectors, L=2m cables, Car Camera Audio output (RCA), Car battery cable 12V. Software updates through USB-C port, black rugged cover. Female 4 PIN Nexus IMSA
	6100008	428,00	Z FEARLESS: Professional Digital Amplifier, Digital Noise Filters and Voice Equalisation, Multifunction Touch Display, Bluetooth, Nexus connectors, L=2m cables, Car Camera Audio output (RCA), Radio IN/OUT, Car battery cable 12V. Male 4 PIN Nexus
	6100009	428,00	Z FEARLESS: Professional Digital Amplifier, Digital Noise Filters and Voice Equalisation, Multifunction Touch Display, Bluetooth, Nexus connectors, L=2m cables, Car Camera Audio output (RCA), Radio IN/OUT, Car battery cable 12V. Female 4 PIN Nexus
	6100010	428,00	Z FEARLESS: Professional Digital Amplifier, Digital Noise Filters and Voice Equalisation, Multifunction Touch Display, Bluetooth, Nexus connectors, L=2m cables, Car Camera Audio output (RCA), Radio IN/OUT, Car battery cable 12V. Female 4 PIN Nexus (comp. IMSA)
N	6100038	285,00	Z FURY: Digital amplifier that makes the incomparable quality of Zeronoise adaptive noise cancelling available to all drivers. FURY combines the digital sound quality with the simplicity of use. The four pre-set buttons had been carefully designed to refine the sound in any condition. They both work independently or combined. TERRAIN: The noise cancelling algorithm focusses on the noises coming from the road surface. BOOST: It enhances the voice volume output for the most demanding drivers. ENGINE: This pre-set is effective on the noises coming from the engine. ROAD/STAGE: Stage mode turns off the radio output, so the communication is solely between drive and co-driver for maximum focus. DIGITAL - MALE 4 PIN NEXUS
N	6100039	285,00	Z FURY: Digital amplifier that makes the incomparable quality of Zeronoise adaptive noise cancelling available to all drivers. FURY combines the digital sound quality with the simplicity of use. The four pre-set buttons had been carefully designed to refine the sound in any condition. They both work independently or combined. TERRAIN: The noise cancelling algorithm focusses on the noises coming from the road surface. BOOST: It enhances the voice volume output for the most demanding drivers. ENGINE: This pre-set is effective on the noises coming from the engine. ROAD/STAGE: Stage mode turns off the radio output, so the communication is solely between drive and co-driver for maximum focus. FEMALE 4 PIN NEXUS
N	6100040	285,00	Z FURY: Digital amplifier that makes the incomparable quality of Zeronoise adaptive noise cancelling available to all drivers. FURY combines the digital sound quality with the simplicity of use. The four pre-set buttons had been carefully designed to refine the sound in any condition. They both work independently or combined. TERRAIN: The noise cancelling algorithm focusses on the noises coming from the road surface. BOOST: It enhances the voice volume output for the most demanding drivers. ENGINE: This pre-set is effective on the noises coming from the engine. ROAD/STAGE: Stage mode turns off the radio output, so the communication is solely between drive and co-driver for maximum focus. FEMALE 4 PIN NEXUS (COMP. IMSA)
	6100002	183,00	Z BRAVE: Analog Amplifier with advanced noise cancelling, two independent volume knobs, Nexus connectors, L=2m cables, Car Camera Audio output (RCA), Internal Battery 9V, Car battery cable 12V. Male 4 PIN Nexus
	6100003	183,00	Z BRAVE: Analog Amplifier with advanced noise cancelling, two independent volume knobs, Nexus connectors, L=2m cables, Car Camera Audio output (RCA), Internal Battery 9V, Car battery cable 12V. Female 4 PIN Nexus

R	Ref	Euro		Description
	6100004	183,00	Z	BRAVE: Analog Amplifier with advanced noise cancelling, two independent volume knobs, Nexus connectors, L=2m cables, Car Camera Audio output (RCA), Internal Battery 9V, Car battery cable 12V. Female 4 PIN Nexus (comp. IMSA)
	6100029	84,00	Z	VALIANT: Entry level Amplifier with Analog Noise Cancelling, Female 6.35mm (STEREO) connectors, L=2m cables, Car Camera audio output, Internal Battery 9V, Car battery cable 12V. Case with grey rugged cover. Female Jack Stereo 6.35mm Connector
PIT-LINK KART TRAINER - KARTING COMMUNICATION SYSTEM				
	6100024	597,00	Z	KART TRAINER - PRO KIT (Driver&Pit): PIT-LINK TRAINER is a full Bluetooth Communication Kit for Karting or Circuit. PRO KIT includes: 2 Wearable Digital Amplifier USB rechargeable (one for pit, one for driver), helmet microphone kit with USB-C plug, professional earplugs 3.5mm jack. Smartphone professional headset (wearable device compatible - not for smartphone) for the pit lane with USB-C plug.
	6100031	158,00	Z	KART TRAINER - WEARABLE AMPLIFIER: Wearable Digital Amplifier USB rechargeable. Bluetooth smartphone connection. USB-C port for charging and connect radio helmet kit (part n° 6300026)
	6100032	522,00	Z	KART TRAINER - PRO KIT (Driver&Pit): PIT-LINK TRAINER is a full Bluetooth Communication Kit for Karting or Circuit. PRO KIT includes: Wearable Digital Amplifier USB rechargeable, helmet microphone kit with USB-C plug, professional earplugs 3.5mm jack. Smartphone professional headset (Android compatible) for the pit lane with 3.5mm jack.
	6100033	312,00	Z	KART TRAINER - BASIC KIT (Driver): PIT-LINK TRAINER is a full Bluetooth Communication Kit for Karting or Circuit. BASIC KIT includes: Wearable Digital Amplifier USB rechargeable, helmet microphone kit with USB-C plug, professional earplugs 3.5mm jack.
	6100034	522,00	Z	KART TRAINER - PRO KIT (Driver&Pit): PIT-LINK TRAINER is a full Bluetooth Communication Kit for Karting or Circuit. PRO KIT includes: Wearable Digital Amplifier USB rechargeable, helmet microphone kit with USB-C plug, professional earplugs 3.5mm jack. Smartphone professional headset (iPhone compatible) for the pit lane with 3.5mm jack.
	6200005	269,00	Z	SMARTPHONE HEADSET: Professional Headset with Noise cancelling Microphone, Jack 3.5mm connector for smartphone. WITH PTT BUTTON - Android compatible
	6200006	269,00	Z	SMARTPHONE HEADSET: Professional Headset with Noise cancelling Microphone, Jack 3.5mm connector for smartphone. WITH PTT BUTTON - iPhone compatible
	6200007	350,00	Z	WEARABLE AMPLIFIER HEADSET: Professional Headset with Noise cancelling Microphone, USB-C connector. With PTT Button. Exclusively compatible with wearable device PIT LINK KART TRAINER my2022 part n° 6100031 (INCLUDED IN THE BOX).
HEADSETS				
N	6200009	385,00	Z	Headset WW: Professional Headset with Noise Cancelling Microphone, High efficiency Speakers, Nexus connector, and coiled cable. Integrated WW technology. Optional Female 4 PIN Nexus cable available (6200010)
N	6200010	85,00	Z	Wiring for Headset WW Female Nexus 4 PIN Connector
	6200002	190,00	Z	ZERONOISE HEADSET: Professional Headset with Noise Cancelling Microphone, High efficiency Speakers, Nexus connector, and coiled cable. HEADSET ZERONOISE- Female 4 PIN Nexus
	6200003	190,00	Z	ZERONOISE HEADSET: Professional Headset with Noise Cancelling Microphone, High efficiency Speakers, Nexus connector, and coiled cable. HEADSET ZERONOISE- Male 4 PIN Nexus
	6200004	190,00	Z	ZERONOISE HEADSET: Professional Headset with Noise Cancelling Microphone, High efficiency Speakers, Nexus connector, and coiled cable. HEADSET ZERONOISE- Male 4 PIN Nexus (comp. IMSA)
	6200001	140,00	Z	VALIANT HEADSET: Entry Level Headset with Electret Noise Cancelling microphone Male Jack 6.35mm STEREO connector and coiled cable.
	6200005	269,00	Z	SMARTPHONE HEADSET: Professional Headset with Noise cancelling Microphone, Jack 3.5mm connector for smartphone. WITH PTT BUTTON - ANDROID
	6200006	269,00	Z	SMARTPHONE HEADSET: Professional Headset with Noise cancelling Microphone, Jack 3.5mm connector for smartphone. WITH PTT BUTTON - IPHONE
	6200007	350,00	Z	WEARABLE AMPLIFIER HEADSET: Professional Headset with Noise cancelling Microphone, USB-C connector. With PTT Button. Exclusively compatible with wearable device PIT LINK KART TRAINER my2022 part n° 6100031 (INCLUDED IN THE BOX).
RADIO HELMET KIT - JET HELMETS				
N	6300036	199,00	Z	RADIO HELMET KIT FOR JET HELMET - WW Radio kit 10 series
	6300001	199,00	Z	RADIO HELMET KIT FOR JET HELMET - Female Nexus 4 PIN STD - with Microphone Flex Boom - with Earcups
	6300002	79,00	Z	RADIO HELMET KIT FOR JET HELMET - Female Nexus 4 PIN STD - with Microphone Flex Boom - NO Earcups
	6300003	199,00	Z	RADIO HELMET KIT FOR JET HELMET WITH HALF CHIN BAR - Female Nexus 4 PIN STD - NO Microphone Flex Boom - with Earcups
	6300004	199,00	Z	RADIO HELMET KIT FOR JET HELMET - Male Nexus 4 PIN STD - with Microphone Flex Boom - with Earcups
	6300005	83,00	Z	RADIO HELMET KIT FOR JET HELMET - Male Nexus 4 PIN STD - with Microphone Flex Boom - NO Earcups
	6300006	199,00	Z	RADIO HELMET KIT FOR JET HELMET - Male Nexus 4 PIN IMSA - with Microphone Flex Boom - with Earcups
	6300007	83,00	Z	RADIO HELMET KIT FOR JET HELMET - Male Nexus 4 PIN IMSA - with Microphone Flex Boom - NO Earcups
	6300008	35,00	Z	RADIO HELMET KIT FOR JET HELMET - 6.35mm STEREO CONNECTOR - with Microphone Flex Boom - NO Earcups
	6300024	179,00	Z	RADIO HELMET KIT FOR JET HELMET - Male Nexus 4 PIN, RCA Female connector
	6300025	179,00	Z	RADIO HELMET KIT FOR JET HELMET - Male Nexus 4 PIN, 3.5mm Female connector
RADIO HELMET KIT - FULL FACE HELMETS				
	6300009	199,00	Z	RADIO HELMET KIT FOR FULL FACE HELMET - Male Nexus 4 PIN STD - with Earcups and Speaker Pads Integrated
	6300010	83,00	Z	RADIO HELMET KIT FOR FULL FACE HELMET - Male Nexus 4 PIN STD - with Integrated Speaker Pads
	6300011	179,00	Z	RADIO HELMET KIT FOR FULL FACE HELMET - Male Nexus 4 PIN STD - with RCA connector for earplugs

R	Ref	Euro		Description
	6300012	179,00	Z	RADIO HELMET KIT FOR FULL FACE HELMET - Male Nexus 4 PIN STD - with 3.5mm stereo connector for earplugs
	6300013	199,00	Z	RADIO HELMET KIT FOR FULL FACE HELMET - Male Nexus 5 PIN STD - with RCA connector for earplugs
	6300014	199,00	Z	RADIO HELMET KIT FOR FULL FACE HELMET - Male Nexus 4 PIN IMSA - with Earcups and Speaker Pads Integrated
	6300015	83,00	Z	RADIO HELMET KIT FOR FULL FACE HELMET - Male Nexus 4 PIN IMSA- with Integrated Speaker Pads
	6300016	179,00	Z	RADIO HELMET KIT FOR FULL FACE HELMET - Male Nexus 4 PIN IMSA - with RCA connector for earplugs
	6300017	179,00	Z	RADIO HELMET KIT FOR FULL FACE HELMET - Male Nexus 4 PIN IMSA - with 3.5mm stereo connector for earplugs
	6300018	199,00	Z	RADIO HELMET KIT FOR FULL FACE HELMET -Male Nexus 5 PIN IMSA - with RCA connector for earplugs
	6300019	32,00	Z	RADIO HELMET KIT FOR FULL FACE HELMET - 6.35mm STEREO CONNECTOR - with Integrated Speaker Pads
	6300023	83,00	Z	RADIO HELMET KIT FOR FULL FACE HELMET - Female Nexus 4 PIN with speaker pads
	6300026	131,00	Z	RADIO HELMET KIT FOR FULL FACE HELMET - USB-C CONNECTOR FOR PIT-LINK TRAINER 6100031- with 3.5mm stereo connector for earplugs
	6300027	199,00	Z	RADIO HELMET KIT FOR FULL FACE HELMET - Female Nexus 4 PIN - with Earcups
	6300028	220,00	Z	Semicustom earplugs with short ear canal and cleaning kit (3.5mm Male Connector)
	6300029	220,00	Z	Semicustom earplugs with long ear canal and cleaning kit (3.5mm Male Connector)
	6300030	158,00	Z	Earplugs kit with foam tips (3.5mm Male Connector)
	6300031	220,00	Z	Semicustom earplugs with short ear canal and cleaning kit (RCA Male Connector)
	6300032	220,00	Z	Semicustom earplugs with long ear canal and cleaning kit (RCA Male Connector)
	6300033	158,00	Z	Earplugs kit with foam tips (RCA Male Connector)
	6300034	79,00	Z	EARCUPS WITH SPEAKERS - RCA MALE (CINCH CONNECTOR) for full face helmets
	6300035	79,00	Z	EARCUPS WITH SPEAKERS - 3.5 MM STEREO PLUG for full face helmets

ADAPTORS AND EXTENSIONS

	6400004	70,00	Z	ADAPTER crossed wiring L=15cm - coiled cable - M/NEXUS 4 PIN STD: M/NEXUS 4 PIN STD
	6400005	70,00	Z	ADAPTER crossed wiring L=15cm - coiled cable - F/NEXUS 4 PIN STD : F/NEXUS 4 PIN STD
	6400006	70,00	Z	ADAPTER extension L=150cm - coiled cable - M/NEXUS 4 PIN STD : F/NEXUS 4 PIN STD
	6400007	70,00	Z	ADAPTER crossed wiring L=15cm-coiled cable - M/NEXUS 4 PIN STD : M/NEXUS 4 PIN IMSA
	6400008	70,00	Z	ADAPTER L=15cm-coiled cable -F/NEXUS 4 PIN IMSA : F/NEXUS 4 PIN STD
	6400009	70,00	Z	ADAPTER crossed wiring L=15cm-coiled cable - M/NEXUS 4 PIN IMSA : F/NEXUS 4 PIN STD
	6400010	81,00	Z	ADAPTER - L=50cm - M/NEXUS 4 PIN STD : M/Jack3.5 for Smartphone
	6400011	81,00	Z	ADAPTER - L=50cm - F/NEXUS 4 PIN STD : M/Jack3.5 for Smartphone
	6400012	81,00	Z	ADAPTER - L=15cm - F/NEXUS 4 PIN STD : M/NEXUS 5 PIN STD
	6400013	81,00	Z	ADAPTER - L=15cm - M/NEXUS 4 PIN STD : M/NEXUS 5 PIN STD
	6400014	81,00	Z	ADAPTER - L=15cm - F/NEXUS 4 PIN IMSA: M/NEXUS 5 PIN IMSA
	6400015	26,00	Z	CONNECTOR NEXUS - MALE 4 PIN
	6400016	37,00	Z	CONNECTOR NEXUS - FEMALE 4 PIN
	6400021	99,00	Z	ADAPTER EXTENSION L=15CM - COILED CABLE - FEMALE 4 PIN STD+RCA : MALE 4 PIN STD
	6400022	99,00	Z	ADAPTER CROSSED WIRING L=15CM-COILED CABLE - MALE 4 PIN STD+RCA : MALE 4 PIN STD
	6400023	99,00	Z	ADAPTER CROSSED WIRING L=15CM-COILED CABLE - FEMALE 4 PIN STD+RCA : FEMALE 4 PIN STD

ACCESSORIES AND SPARES

N	6100042	370,00	Z	Wireless module and side cover
N	6400024	5,00	Z	Replacement microphone foam cover
	6100013	28,00	Z	Single PTT button with USB-C Connector (length 2m)
	6100014	56,00	Z	Double PTT button with USB-C Connector (for driver and co-driver, length 2m)
	6100018	22,00	Z	Amplifier COVER RED in silicon rubber - Smooth
	6100019	28,00	Z	Amplifier COVER RED in silicon rubber - Rugged
	6100030	28,00	Z	Amplifier COVER BLACK in silicon rubber - Rugged
	6100035	28,00	Z	Amplifier COVER GREY in silicon rubber - Rugged
	6100037	380,00	Z	Wiring for Fearless WRC CanBus amplifier Wires and Deutsch connectors from the Fearless WRC CanBus amplifier to the car. Available upon request.
	6400017	42,00	Z	12V Power Filter works between the intercom and the 12V power source. It filters audio signal and drastically reduces interferences.
	6400018	89,00	Z	Radio cable ADP equipped with PTT button and connection to UHF/VHF radio. MADE TO ORDER.
	6400019	6,00	Z	Replacement Foam Tips for earplugs

SEATS

* Refers To Complete Seat (fia 8855-1999
Refers To Shell (fia 8862-2009
10% Tolleranc

R	Ref	Euro	Description	Weight*	Shell	Fixing	Colour
RACING SEATS FIA 8862/2009 HOMOLOGATED							
N	HA0-0829-A01		D HTE ONE ULTRA LITE: Top level seat in compliance with the FIA 8862-2009 homologation, totally realized in ultralightweight carbon fiber shell with exclusive technology for maximum resistance and lightness. Large shoulder harness slots. Airnet and velour upholstery. EXTREMELY LIGHTWEIGHT VERSION OF HTE ONE LITE SEAT, AVAILABLE UPON REQUEST.	5	Carbon	Side W type	Black (HA0-0829-A01-071)
	HA0-0800-A01	8,600.00	D HRC ONE LITE: Ultra lightweight carbon fiber seat FIA 8862-2009 homologated. High protection shoulder and head containment. Designed to allow installation and comfortable driving position also in GT cars with reduced internal room. Airnet and velour upholstery. HC0-0929-A01 bracket required. TOP LEVEL VERSION OF HRC ONE SEAT, HIGH RESISTANT AND ULTRALIGHT SHELL (WEIGHT AT THE MINIMUM VALUE ALLOWED BY FIA).	6,8	Carbon	Side W type	Black (HA0-0800-A01-071)
	HA0-0807-A01	9,850.00	D HTE ONE LITE: Seat in compliance with the FIA 8862-2009 homologation, totally realized in ultralightweight carbon fiber shell with exclusive technology for maximum resistance and lightness. Large shoulder harness slots. Airnet and velour upholstery. HC0-0934 bracket required (not included). TOP LEVEL VERSION OF HTE ONE SEAT, HIGH RESISTANT AND ULTRALIGHT SHELL (WEIGHT AT THE MINIMUM VALUE ALLOWED BY FIA).	7,5	Carbon	Side W type	Black (HA0-0807-A01-071)
	HA0-0805-A01	8,850.00	D HRC ONE LITE RC: Lightweight carbon fiber seat FIA 8862-2009 homologated. High protection shoulder and head containment. Designed to allow installation and comfortable driving position also in GT cars with reduced internal room. Airnet and velour upholstery. HC0-0929-A02 bracket required. HRC ONE SEAT VERSION WITH TWO ATTACHMENT POINTS TO THE ROLL CAGE (MANDATORY REQUIREMENT FOR GT3 CARS HOMOLOGATED AFTER JANUARY 1st, 2019).	6,8	Carbon	Side W type	Black (HA0-0805-A01-071)
	HA0-0798-A01	7,200.00	D HTE ONE XL: Seat in compliance with the FIA 8862-2009 homologation (+300% increased resistance) totally realized in lightweight carbon fiber shell with exclusive technology for maximum resistance and lightness. Large shoulder harness slots. Back, lateral and base cushions removable, split leg rests to allow maximum individual seating comfort. Upholstered customized on demand. Hans@ compatible. It is mandatory to fix the seat with the bracket HC0-0928 NOT INCLUDED. XL VERSION	10,1	Carbon	Side W type	Black (HA0-0798-A01-071)
	HA0-0825-A01	6,100.00	D HTE ONE E2: Seat in compliance with the FIA 8862-2009 homologation (+300% increased resistance) totally realized in lightweight carbon fiber shell with exclusive technology for maximum resistance and lightness. Large shoulder harness slots. Back, base and split leg cushions removable to allow maximum individual seating comfort. Customized upholstery upon request. Hans@ compatible. It is mandatory to mount the seat with the bracket HC0-0935-A02 NOT INCLUDED.	9,6	Carbon	Side W type	Black (HA0-0825-A01-071)
	HA0-0789-A01	6,600.00	D HRC ONE: Carbon fiber seat, FIA 8862-2009 homologated. High protection shoulder and head containment. Designed to allow installation and comfortable driving position also in GT cars with reduced internal room. Fire-resistant Airnet and velour upholstery. It is mandatory to fix the seat with the bracket HC0-0907 NOT INCLUDED.	9,2	Carbon	Side W type	Black (HA0-0789-A01-071)
	HA0-0815-A01	4,800.00	D HTC ONE: FIA 8862-2009 homologated carbon fiber seat with best lightness/price rate. High protection shoulder and head containment, designed to allow installation and comfortable driving position also in GT cars with reduced internal room. Two size available: L (standard), M (20mm thicker upholstery to get higher containment). It is mandatory to fix the seat with the bracket HC0-0935-A01 NOT INCLUDED.	9	Carbon	Side W type	Black sz L (HA0-0815-A01-071-L) Black sz M (HA0-0815-A01-071-M)
RACING SEATS FIA 8855/2021 HOMOLOGATED							
	HA0-0902-A01	3,200.00	D HTE EVO2 CARBON: FIA 8855-2021 homologated carbon fiber seat. Innovative ultraproductive shell inspired by the multi world champion OMP HTE ONE seat. High protection and containment, designed to accommodate various heights. Large shoulder harness slots. Upholstery in velour and Airnet. Mandatory brackets HC0-0951-A01 excluded.	7,5	Carbon	Side W type	Black (HA0-0902-A01-071)
	HA0-0900-A01	3,000.00	D HTC EVO CARBON: FIA 8855-2021 homologated carbon fiber seat with best lightness/price rate. High protection shoulder and head containment, designed to allow installation and comfortable driving position also in GT cars with reduced internal room. Mandatory brackets HC0-0945 excluded.	7,8	Carbon	Side W type	Black (HA0-0900-A01-071)

R	Ref	Euro	Description	Weight	Shell	Fixing	Colour
N	HA0-0904-A01	1,440.00	C HTE EVO XL: FIA 8855-2021 homologated fiberglass seat. Innovative ultraproductive shell inspired by the multi world champion OMP HTE ONE seat. High protection and containment, designed to accomodate various heights. Large shoulder harness slots. Upholstering in new 3D velour and anti-slip point. "XL" SHAPE: LARGER VERSION OF HTE EVO SEAT.		Fiberglass	Side W type	Black (HA0-0904-A01-071)
	HA0-0901-A01	1,390.00	C HTE EVO VTR: FIA 8855-2021 homologated fiberglass seat. Innovative ultraproductive shell inspired by the multi world champion OMP HTE ONE seat. High protection and containment, designed to accomodate various heights. Large shoulder harness slots. Upholstering in new 3D velour and anti-slip point. Mandatory brackets HC0-0951-A02 excluded.	12,6	Fiberglass	Side W type	Black (HA0-0901-A01-071)
N	HA0-0905-A01	1,340.00	C HTE EVO S: FIA 8855-2021 homologated fiberglass seat. Innovative ultraproductive shell inspired by the multi world champion OMP HTE ONE seat. High protection and containment, designed to accomodate various heights. Large shoulder harness slots. Upholstering in new 3D velour and anti-slip point. "S" SHAPE: COMPACT VERSION OF HTE EVO SEAT, SUITABLE FOR SMALL-SIZED COCKPIT.		Fiberglass	Side W type	Black (HA0-0905-A01-071)
	HA0-0903-A01	1,290.00	C HTC EVO VTR: FIA 8855-2021 homologated fiberglass seat with best lightness/price rate. High protection shoulder and head containment, designed to allow installation and comfortable driving position also in GT cars with reduced internal room. Upholstering in new 3D velour and kinder point. Mandatory brackets HC0-0951-A03 excluded.	12,5	Fiberglass	Side W type	Black (HA0-0903-A01-071)
RACING SEATS FIA 8855/1999 HOMOLOGATED							
	HA0-0786-A01	3,600.00	C HRC-R Carbon Air: Preimpregnated carbon fiber seat with head containment. Designed to allow installation and comfortable driving position also in GT cars with reduced internal room. Prepared shell for air cooling system installation. Three sizes available to allow maximum individual seating comfort (cushions HB/701, HB/702). INCLUDES AIR COOLING SYSTEM HC/913 AND PREFORATED BACK CUSHION HB/703.	6	Carbon	Side W type	Black sz. L (standard) (HA0-0786-A01-071-L) Black sz. M (with cushions) (HA0-0786-A01-071-M) Black sz. S (with cushions) (HA0-0786-A01-071-S)
	HA0-0788-A01	2,650.00	C HRC-R Carbon: Carbon fiber seat with head containment. Designed to allow installation and comfortable driving position also in GT cars with reduced internal room. Three sizes available to allow maximum individual seating comfort (cushions HB/701, HB/702).	6	Carbon	Side W type	Black sz. L (standard) (HA0-0788-A01-071-L) Black sz. M (with cushions) (HA0-0788-A01-071-M) Black sz. S (with cushions) (HA0-0788-A01-071-S)
	HA0-0768-B01	2,350.00	C HTE CARBON: Seat carbon fibre shell molded in autoclave. Perforated seat shell. Rear holes for compatibility with ventilation system AIR FLOW. Large shoulder harness slots to accommodate various heights. High side bolsters for lateral leg support. Shaped security headrest. Removable back cushion, base, split leg rests to allow maximum individual seating comfort. Rubber dots for improved grip inserts. Upholstered entirely in high breathability AIRNET material. Upholstered customized on demand.HANS® and HSC PATENT (HC/893) compatible.	6,6	Carbon	Side W type	Black (HA0-0768-B01-071)
	HA0-0779-B01	2,950.00	C HTE CARBON XL: Seat carbon fibre shell molded in autoclave. Perforated seat shell. Rear holes for compatibility with ventilation system AIR FLOW. Large shoulder harness slots to accommodate various heights. High side bolsters for lateral leg support. Shaped security headrest. Removable back cushion, base, split leg rests to allow maximum individual seating comfort. Rubber dots for improved grip inserts. Upholstered entirely in high breathability AIRNET material. Upholstered customized on demand.HANS® and HSC PATENT (HC/893) compatible. XL VERSION LARGER AND HIGHER.	6,8	Carbon	Side W type	Black (HA0-0779-B01-071)
	HA0-0745-A01	2,350.00	C PROTOTIPO: Seat with lightweight carbon fibre shell. Backrest inclination specific for GT cars. Large shoulder harness slots to accommodate various heights. High side bolsters for lateral leg support for higher protection. Removable head,back, lateral and base cushions, split leg rests to allow maximum individual seating comfort. Completely covered in velour. Hans® compatible.	6,1	Carbon	Side W type	Black (HA0-0745-A01-071)
	HA0-0817-A01	3,100.00	D HTE EVO Carbon: FIA 8855-1999 homologated carbon fiber seat. Innovative ultraproductive shell inspired by the multi world champion OMP HTE ONE seat. High protection and containment, designed to accomodate various heights. Large shoulder harness slots. Upholstering in velour and Airmet.	6	Carbon	Side W type	Black (HA0-0817-A01-071)
	HA0-0818-A01	589.00	C HTE EVO: FIA 8855-1999 homologated fiberglass seat. Innovative ultraproductive shell inspired by the multi world champion OMP HTE ONE seat. High protection and containment, designed to accomodate various heights. Large shoulder harness slots. Upholstering in velour and Airmet.	9,9	Fiberglass	Side W type	Black (HA0-0818-A01-071)
	HA0-0794-A01	699.00	C HRC Fiberglass Air XL: New racing seat with fiberglass shell and high protection shoulder and head containment. Designed to allow a comfortable driving position. Fire-resistant Airmet and velour upholstery. Predrilled shell to allow cooling kit installation (HC/913). XL VERSION, HIGHER AND LITTE LARGER THAN STANDARD SEAT FOR DRIVERS TALLER THAN 180-185 CM.	10,3	Fiberglass	Side W type	Black (HA0-0794-A01-071)

R	Ref	Euro	Description	Weight	Shell	Fixing	Colour
	HA0-0771-B01	650,00	C HTE XL: Seat in gel coated fiberglass shell. Large shoulder harness slots to accommodate various heights. High side bolsters for lateral leg support. Shaped security headrest. Removable back cushion, base, split leg rests to allow maximum individual seating comfort. Rubber dots for improved grip inserts. Upholstered entirely in high breathability AIRNET material. HANS® and HSC PATENT (HC/893) compatible. XL VERSION LARGER AND HIGHER.	9,8	Fiberglass	Side W type	Black (HA0-0771-B01-071)
	HA0-0793-A01	640,00	C HRC Fiberglass Air: New racing seat with fiberglass shell and high protection shoulder and head containment. Designed to allow installation and comfortable driving position also in GT cars with reduced internal room. The velvet side is though for the application of containment cushions, which are available in 2 sizes (M or S, ref. HB/701). The base cushion is also available in thicker version (50mm, ref. HB/702). Fire-resistant Airnet and velour upholstery. Pre-drilled shell to allow cooling kit installation (HC/913).	9,5	Fiberglass	Side W type	Black (HA0-0793-A01-071)
	HA0-0778-B01	599,00	C WRC XL: Seat gel-coated fiberglass shell. Large shoulder harness slots to accommodate various heights. High side bolsters for lateral leg support for higher protection. Removable back, base and leg cushion for maximum individual seating comfort. Upholstered entirely in new high breathability AIRNET material. Upholstered customized on demand. HANS® compatible. XL VERSION LARGER AND HIGHER.	10,9	Fiberglass	Side W type	Black (HA0-0778-B01-071)
	HA0-0780-B01	580,00	C HTE 400: Seat in gel coated fiberglass shell. Large shoulder harness slots to accommodate various heights. Medium height side bolsters for lateral leg support. Removable back, base and leg cushion for maximum individual seating comfort. Upholstered entirely in high breathability AIRNET material. Upholstered customized on demand. HANS® and HSC PATENT (HC/893) compatible. ESPECIALLY FOR CARS WITH SMALL SPACE IN THE UPPER PART.	9,8	Fiberglass	Side W type	Black (HA0-0780-B01-071)
	HA0-0772-B01	570,00	C HTE: Seat in gel coated fiberglass shell. Large shoulder harness slots to accommodate various heights. High side bolsters for lateral leg support. Shaped security headrest. Removable back cushion, base, split leg rests to allow maximum individual seating comfort. Rubber dots for improved grip inserts. Upholstered entirely in high breathability AIRTEX® material. HANS® and HSC PATENT (HC/893) compatible.	9,9	Fiberglass	Side W type	Black (HA0-0772-B01-071)
	HA0-0772-B02	850,00	C HTE ART: Seat in gel coated fiberglass shell. Large shoulder harness slots to accommodate various heights. High side bolsters for lateral leg support. Shaped security headrest. Removable back cushion, base, split leg rests to allow maximum individual seating comfort. Rubber dots for improved grip inserts. Upholstered entirely in high breathability AIRTEX® material. HANS® and HSC PATENT (HC/893) compatible. "ART" VERSION WITH CUSTOMIZABLE TOTALLY PRINTED GRAPHIC. AVAILABLE ONLY UPON REQUEST.	9,9	Fiberglass	Side W type	Custom
	HA0-0773-B01	510,00	C WRC: Seat gel-coated fiberglass shell. Large shoulder harness slots to accommodate various heights. High side bolsters for lateral leg support for higher protection. Removable back, base and leg cushion for maximum individual seating comfort. Upholstered entirely in new high breathability AIRNET material. Upholstered customized on demand. HANS® and HSC PATENT compatible.	8,9	Fiberglass	Side W type	Black (HA0-0773-B01-071)
	HA0-0773-B02	810,00	C WRC ART: Seat gel-coated fiberglass shell. Large shoulder harness slots to accommodate various heights. High side bolsters for lateral leg support for higher protection. Removable back, base and leg cushion for maximum individual seating comfort. Upholstered entirely in new high breathability AIRNET material. Upholstered customized on demand. HANS® and HSC PATENT compatible. "ART" VERSION WITH CUSTOMIZABLE TOTALLY PRINTED GRAPHIC. AVAILABLE ONLY UPON REQUEST.	8,9	Fiberglass	Side W type	Custom
	HA0-0774-B01	499,00	C ARS: Seat in gel-coated fiberglass shell. Large shoulder harness slots to accommodate various heights. Medium height side bolsters for lateral leg support. Removable back, base and leg cushion for maximum individual seating comfort. Upholstered entirely in high breathability AIRNET material. HANS® and HSC PATENT (HC/893) compatible.	9,9	Fiberglass	Side W type	Black (HA0-0774-B01-071)
	HA0-0762-B01	479,00	C RS-P.T. 2: Fiberglass shell seat. Large shoulder harness slots to accommodate various heights. High side bolsters for lateral leg support for higher protection. Shaped Security Headrest to limit lateral movement of the helmet. Removable back cushion and split leg rests to allow maximum individual seating comfort. Completely covered in velour. HANS® and HSC PATENT compatible.	10,4	Fiberglass	Side W type	Black (HA0-0762-B01-071)
	HA0-0766-B01	359,00	C CHAMP: Gel-coated fiberglass shell seat. Large shoulder harness slots to accommodate various heights. Removable back cushion and split leg rests to allow maximum individual seating comfort. Base and shoulders upholstered with anti-slip material to allow the maximum adherence to the seat. Completely covered in velour. HANS® compatible.	8,9	Fiberglass	Side W type	Black (HA0-0766-B01-071)
	HA0-0790-A01	335,00	C FIRST-R: New entry level seat with fiberglass shell, upholstered entirely in velour. HANS® compatible. W side fixing points, 5 harness slots. High side bolsters for lateral leg support and removable base cushion.	9,4	Fiberglass	Side W type	Black (HA0-0790-A01-071)

R	Ref	Euro	Description	Weight	Shell	Fixing	Colour
	HA0-0760-B01	285.00	C TRS SKY: Tubular steel frame seat. Large shoulder harness slots to accommodate various heights. Medium height side bolsters for lateral leg support for higher protection. Removable leg rests to allow maximum individual seating comfort. Upholstered in black vinyl. HANS® compatible.	10,8	Tubular steel	Side - Bottom Y and W type	Black (HA0-0760-B01-071)
	HA0-0781-B01	265.00	C TRS XL: Tubular steel frame seat. Large shoulder harness slots to accommodate various heights. Medium height side bolsters for lateral leg support for higher protection. Removable leg rests to allow maximum individual seating comfort. Upholstered entirely in jacquard velour. HANS® compatible. XL VERSION LARGER AND HIGHER.	12,3	Tubular steel	Side W type	Black (HA0-0781-B01-071)
	HA0-0803-B01	255.00	C TRS-X: Tubular steel frame seat. Excellent quality/price ratio, large shoulder harness slots to accommodate various heights. Medium height side bolsters for lateral leg support and higher protection. Removable leg rests, upholstered entirely in velour. The optimized dimensions allows to mounting the seat also in cars with reduced inner room and the ergonomic is designed to guarantee the best individual seat comfort and an high lateral support. HANS® compatible. Exclusive design thanks to modern shape and highlighted details.	10,8	Tubular	Bottom Y type	Black (HA0-0803-B01-071)
	HA0-0741-B01	227.00	C TRS: Tubular steel frame seat. Large shoulder harness slots to accommodate various heights. Medium height side bolsters for lateral leg support for higher protection. Removable leg rests to allow maximum individual seating comfort. Upholstered entirely in velour. HANS® compatible.	10,3	Tubular steel	Side - Bottom Y and W type	Red (HA0-0741-B01-061) Blue (HA0-0741-B01-041) Black (HA0-0741-B01-071)

BUCKET RACING SEATS FIA 8855/1999 HOMOLOGATED

N	HA0-0831-A01	1,590.00	C RT Carbon: Bucket racing seat in carbon fiber FIA 8855-1999 homologated. The ergonomic shape and the removable soft padded inserts upholstered in fine material make the seat comfortable in every condition, from tuning to racing. Innovative shoulder harness slots design, wide leg cushion to improve driving comfort and lower side to facilitate the cockpit access. Full leather upholstery and padding.	9,5	Carbon	Side W type	Black (HA0-0831-A01-071)
N	HA0-0831-A02	1,590.00	C RT Carbon: Bucket racing seat in carbon fiber FIA 8855-1999 homologated. The ergonomic shape and the removable soft padded inserts upholstered in fine material make the seat comfortable in every condition, from tuning to racing. Innovative shoulder harness slots design, wide leg cushion to improve driving comfort and lower side to facilitate the cockpit access. Leather upholstery and Alcantara fabric padding.	9,5	Carbon	Side W type	Black (HA0-0831-A02-071)
N	HA0-0832-A01	690.00	C RT: Bucket racing seat in fiberglass FIA 8855-1999 homologated. The ergonomic shape and the removable soft padded inserts upholstered in fine material make the seat comfortable in every condition, from tuning to racing. Innovative shoulder harness slots design, wide leg cushion to improve driving comfort and lower side to facilitate the cockpit access. Upholstery in leather with Alcantara fabric padding.	10	Fiberglass	Side W type	Black (HA0-0832-A01-071)

VINTAGE SEATS

	HA0-0757-A01	355.00	A BRANDS HATCH: Seat with tubular steel frame. Raised backrest and velvet seat, faux leather sides with rhombus quilting, adjustable velvet headrest for greater comfort.	7,5	Tubular	Bottom Y type	Black (HA0-0757-A01-071)
	HA0-0737-B01	315.00	A CLASSIC: Seat with tubular steel frame. Raised backrest and velvet seat, faux leather sides, adjustable velvet headrest for greater comfort. M8 lower fixing points 345x270 mm Y.	7,5	Tubular	Bottom Y type	Black (HA0-0737-B01-071)
	HA0-0756-A01	299.00	A SILVERSTONE: vintage seat with tubular steel frame. Faux leather seat and back with vertical quilting, faux leather sides. M8 lower fixing points 345x270 mm Y.	7	Tubular	Bottom Y type	Black (HA0-0756-A01-071)

KART SEATS

	KK0-5030-A02	75.00	C Large kart seat, made in semitransparent fibre glass, available in 2 sizes: 36 cm wide (weight: 1,24 Kg); 38 cm wide (weight: 1,25 Kg). WEIGHT TOLERANCE 10%.				
	KK0-5032	75.00	C Flat kart seats. Sizes: Width 27 cm - weight 1,10 Kg; Width 29 cm - weight 1,20 Kg; Width 30 cm - weight 1,30Kg; Width 31 cm - weight 1,40 Kg; Width 32 cm - weight 1,35 Kg; Width 33 cm - weight 1,45 Kg; Width 36 cm - weight 1,50 Kg; Width 38 cm - weight 1,60 Kg. WEIGHT TOLERANCE 10%.				
	KK0-5030-A01	69.00	C Kart seat, made in semitransparent fibre glass, available in 6 sizes: 27 cm wide (weight: 1,20 Kg); 29 cm wide (weight: 1,30 Kg); 30 cm wide (weight: 1,28 Kg), 31 cm wide (weight: 1,10cm); 32 cm wide (weight: 1,20 Kg); 33 cm wide (weight: 1,22 Kg). WEIGHT TOLERANCE 10%.				
	KK0-0036	33,50	C Seat padding kit 8 mm pre-cut mouldable polyethylene pads for kart seats. All components are self adhesive to facilitate positioning on any seat shell.				

R	Ref	Euro	Description	Weight	Shell	Fixing	Colour
OFF ROAD SEATS							
N	HA0-0830-A01	499,00	C HTE EVO Offroad: Offroad racing seat with innovative ultraprotective shell inspired by the multi world champion OMP HTE ONE seat. High protection and containment, designed to accomodate various heights. Large shoulder harness slots. The full gelcoat finishing and the quick removable neoprene padding allows to easily wash the seat from mud and dirt. Supplied without homologation label fo no FIA rules competition.		Fiberglass	Side W type	Black (HA0-0830-A01-071)
OMP CHAIR							
N	HA0-0836-A01	299,00	P GSX Chair: Wheeled gaming chair upholstered in vinyl with high quality reclining mechanism, hydraulic seat height adjustment and removable 4-way full adjustable armrests. The seat is manufactured with the best quality components available, from the movement elements to the plastic parts. Racing-inspired design with upholstery with 3D effect sewing, racing-spring on piston, colored inserts on wheels and base. The ergonomic high-comfort shape and EN1335 homologation make the chair perfect for your office, at home or in the paddock.				Black vinyl (HA0-0836-A01-071) Black/fluo yellow vinyl (HA0-0836-A01-178) Black/fluo green vinyl (HA0-0836-A01-274) Black/fluo orange vinyl (HA0-0836-A01-179)
N	HA0-0835-A01	269,00	P GS Chair: Wheeled office chair upholstered in vinyl with high quality reclining mechanism, hydraulic seat height adjustment and removable 3-way adjustable armrests. The seat is manufactured with the best quality components available, from the movement elements to the plastic parts. Aluminium base, racing-inspired design with 3D effect sewing. The ergonomic high-comfort shape and EN1335 homologation make the chair perfect for your office, at home or in the paddock.				Black vinyl (HA0-0835-A01-071) Black/yellow vinyl (HA0-0835-A01-178) Black/red vinyl (HA0-0835-A01-073) Black vinyl with breathable Airnet fabric (HA0-0835-A01-276)
N	HB0-0707	25,00	P Cushions set back and headrest in velour for office/gaming chair				Black
N	HB0-0709	13,00	P Head cushion for office and gaming seats				Black
N	HB0-0708	12,00	P Lumbar cushion for gaming/office chairs				Black
AIR COOLING KIT&ACCESSORIES							
	HC0-0914-A01	269,00	C Air blower with rubber adaptor for cooling kit HC/913. The blower (HC/914/V) and the adaptor (HC/914/R) are also available as spare parts.				
	HC0-0913-A01	260,00	C Air cooling kit to be mounted on predrilled seat shell (all OMP "Air" seats). This system give a new level of cooling comfort to the drivers specially during long races in very hot condition. Apply HB/703 cushion (not included) to the seat to get the best cooling effect. The kit includes: - a shell to be mounted on the the back of the seat with included shaped bihadesive tape (HC/913/G) - a connection hose (1,5" x 2mt) with inner metal spiral (HC/913/T) that can be fixed to the shell and to the blower HC/914 or to others air sources (inner intake of the car..) - a connection junction in rubber (HC/913/R) - 45° connection junction in rubber (HC/913/R45) All components are sold also separately as spare parts				
	HC0-0914-A03	220,00	C Spare air blower for HC/914.				
	HC0-0913-A02	146,00	C Shell to be mounted on the the back of the seat (HC/913 spare part). Includes bihadesive tape.				
	HC0-0914-A02	79,00	C Spare rubber adaptor for HC/914.				
	HC0-0913-A05	62,00	C Connection hose (1,5" x 2mt) with inner metal spiral (HC/913 spare part)				
	HC0-0913-A04	36,00	C 45° connection junction in rubber (HC/913 spare part)				
	HC0-0913-A03	31,50	C Connection junction in rubber (HC/913 spare part)				
SEATS CUSHIONS							
	HB0-0701	123,00	C Couple of seat cushions for HRC seats. Sizes M, S				Black size Small (HB0-0701-S) Black size Medium (HB0-0701-M)
	HB0-0703	120,00	C Back preforated cushion for HRC AIR seat. Black. Sizes: standard, XL (for XL "air" seats)				Black (HB0-0703-071) Black sz. XL (HB0-0703-071-XL)
	HB0-0702	67,00	C Seat cushion for HRC seats				Black
	HB0-0698	57,00	C Leg support cushion for HTE seat				Black
	HB0-0695	50,00	C Seat cushion. 330x260mm.				Black
	HB0-0693	48,50	C Removable leg support cushion. 330x220mm.				Black
	HB0-0662	47,50	C Lumbar support cushoin, medium. 300x175mm.				Black
	HB0-0699	47,00	C Head support cushion for WRC and HRC seat				Black
	HB0-0700	47,00	C Leg support cushion for WRC seat				Black
	HB0-0692	27,00	C Lumbar support cushoin, small. 240x100mm.				Black

R	Ref	Euro	Description	Weight	Shell	Fixing	Colour
FIA 8862-2009 HOMOLOGATED SPECIFIC BRACKETS							
	HC0-0907	1,699,00	D	Fixing brackets for HRC ONE seat (HA0-0789-A01). FIA 8862-2009 homologated.			
	HC0-0929-A01	1,699,00	D	Fixing brackets for HRC ONE LITE seat (HA0-0800-A01). FIA 8862-2009 homologated.			
	HC0-0929-A02	1,699,00	D	Fixing brackets for HRC ONE LITE RC seat (HA0-0805-A01). FIA 8862-2009 homologated.			
	HC0-0935-A01	1,383,00	D	Fixing brackets for HTC ONE Seat (HA0-0815-A01). FIA 8862-2009 homologated.			
	HC0-0935-A02	1,383,00	D	Fixing brackets for HTE ONE2 Seat (HA0-0825-A01). FIA 8862-2009 homologated.			
	HC0-0928	401,00	D	Fixing brackets for HTE ONE XL seat (HA0-0798-A01). FIA 8862-2009 homologated.			
	HC0-0934	401,00	D	Fixing brackets for HTE ONE LITE seat (HA0-0807-A01). FIA 8862-2009 homologated.			
	HC0-0880-A01	274,00	D	Fixing brackets for HTE ONE seat (HA0-0761-B01). FIA 8862-2009 homologated.			
	HC0-0880-A02	274,00	D	Fixing brackets for HTE ONE-S seat (HA0-0801-A01). FIA 8862-2009 homologated.			
FIA 8855-2021 HOMOLOGATED SPECIFIC BRACKETS							
	HC0-0951-A01	229,00	C	Fixing brackets for HTE EVO2 CARBON seat (HA0-0902-A01). FIA 8855-2021 homologated.			
	HC0-0951-A02	229,00	C	Fixing brackets for HTE EVO VTR seat (HA0-0901-A01). FIA 8855-2021 homologated.			
	HC0-0951-A03	229,00	C	Fixing brackets for HTC EVO VTR seat (HA0-0903-A01). FIA 8855-2021 homologated.			
N	HC0-0951-A04	229,00	C	Fixing brackets for HTE EVO XL seat (part n° HA0-0904-A01). FIA 8855-2021 homologated.			
N	HC0-0951-A05	229,00	C	Fixing brackets for HTE EVO S seat (part n° HA0-0905-A01). FIA 8855-2021 homologated.			
	HC0-0945	139,00	D	Fixing brackets for HTC EVO CARBON (HA0-0900-A01). FIA 8855-2021 homologated.			
ACCESSORIES AND BRACKETS-COMPLYING WITH FIA							
	HC0-0830	325,00	C	Pair of aluminium brackets for seats featuring side anchorage points; allow the seat to be adjusted both vertically and longitudinally. Professional brackets equipped with a damper, which helps reduce the compressive stress (and associated injuries) on the spinal column while driving. Patented model. Bracket length: 495 mm. Thickness: 6 mm. FIA approved.			Black
	HC0-0893	215,00	C	HSC PATENT: Adjustable aluminium cover kit for 3 positions setting. Designed in compliance with FIA rules to help to find the best position with regard to the height of the person and favour the respect of the required angles. Patented.			
	HC0-0925	152,00	C	Multi hole aluminium seat bracket. FIA ALL-J rules. Minimum 36 different positions. Length: 495 mm Thickness: 6 mm			Black
	HC0-0924	136,00	C	Multi hole aluminium seat bracket. Minimum 16 different positions. Length: 400 mm Thickness: 6 mm. FIA ALL-J rules.			Black
	HD0-0879	109,00	C	Weld-in universal seat subframe to be adapted to the shell of the vehicle. Two 35 mm squared pipes, Length 600 mm, 4 plates for direct welding to the body (80 x 60 thickness 3 mm), 4 plates for direct welding to the tube (60 x 40 thickness 3 mm), 4 buckles for welding M8. FIA ALL-J rules.			
	HC0-0923	106,00	C	Multi hole steel seat bracket. FIA ALL-J rules. Minimum 36 different positions. Length: 495 mm Thickness: 3 mm			Black
	HC0-0922	97,00	C	Multi hole steel seat bracket. Minimum 16 different positions. Length: 400 mm Thickness: 3 mm. FIA ALL-J rules.			Black
	HC0-0660	76,00	C	Pair of steel "L" shaped brackets to fit seats with lower attachment point (type Y) to side brackets. Thickness: 3 mm.			Black
	HC0-0731-B01	76,00	C	Pair of steel brackets for side mounted seats. High model. Thickness: 3 mm. Length: 350 mm. FIA ALL-J rules.			Black
	HC0-0733-B01	58,00	C	Pair of steel brackets for side mounted seats. Low model. Thickness: 3 mm. Length: 350 mm. FIA ALL-J rules.			Black
	HC0-0872	13,00	C	Set of 4 steel self-locking bolts with hexagonal head and relevant 4 washers. mm 10,9 M8 x 1,25 length 25 mm. Complies with FIA norms. To fix the seat to the seat brackets or subframe.			
ACCESSORIES AND BRACKETS							
	HC0-0858	165,00	A	Pair of seat bracket spacer, adjustment in 3 increments: + 50 mm, + 62 mm and + 75 mm with respect to the vehicle specific adaptor. Also allows for seat angle inclination adjustments of 2.5° to 5° seat angle adjustments.			

R	Ref	Euro		Description	Weight	Shell	Fixing	Colour
	HC0-0663	130,00	A	Universal subframe to be used exclusively with sliding rails (art. HC/665). Not FIA approved.				
	HD0-0666	115,00	A	Universal couple of brackets for seat with lower attachments. Aluminium. Not FIA approved.				Silver
	HC0-0857	109,00	A	Pair of seat bracket spacer with double height adjustment. The spacer allows the seat height to be adjusted in 2 increments: + 25 mm or 50 mm above the vehicle specific adaptor, depending on which side is used for mounting.				
	HC0-0729	80,00	A	Pair of flat brackets for fitting side brackets to vehicle specific seat adaptors. Anodized aluminium. Thickness: 10 mm				Black
	XHA-806-KIT	75,00	C	Spare neoprene padding kit for M+S seat (HA/806 - HA/806F)				
	HC0-0665	52,00	A	Sliding rail kit to be mounted between the brackets and the seat. Steel. Not FIA approved.				Black
	HC0-0930	25,00	C	Kit of spare SHOULDER harness slots adaptable on most of OMP racing seat.				Black (HC0-0930-071) White (HC0-0930-020) Red (HC0-0930-061) Fluo green (HC0-0930-039) Fluo orange (HC0-0930-098) Fluo yellow (HC0-0930-099)
	HC0-0931	25,00	C	Kit of spare LATERAL harness slots adaptable on most of OMP racing seat.				Black (HC0-0931-071) White (HC0-0931-020) Red (HC0-0931-061) Fluo green (HC0-0931-039) Fluo orange (HC0-0931-098) Fluo yellow (HC0-0931-099)
	HC0-0664	15,00	A	Aluminium bracket for seat fixing kit.				
	HC0-0932	12,40	C	Spare 5° point harness slot adaptable on most of OMP racing seat.				Black

ADAPTORS FOR SEAT FIXING BRACKETS

Application List

R	Ref	Euro		Car	Year	Ref Art
ALFA ROMEO						
	HD0-0797-R	121,00	A	147		Right
	HD0-0797-L	121,00	A			Left
	HD0-0740	94,00	A	155	>92<97	
	HD0-0905	146,00	A	GIULIA	>74<78	
	HD0-0868	136,00	A	GT-GTA	>63<76	
	HD0-0782	115,00	A	GTV	>97	
	HD0-0862-R	146,00	A	MITO	>06/08	Right
	HD0-0862-L	146,00	A		>06/08	Left
AUDI						
	HD0-0780-R	115,00	A	A3 (8L)	>96 <03	Right
	HD0-0780-L	115,00	A			Left
	HD0-0838-R	129,00	A	A3 (8P / 8PA)	>03	Right
	HD0-0838-L	129,00	A			Left
	HD0-0817	136,00	A	TT	>11/98	
BMW						
	HD0-0848	115,00	A	E87 series 1	>09/04	
	HD0-0848	115,00	A	F22 - F23 series 2 incl. M2	>14	
	HD0-0772	121,00	A	E30 - E36 series 3 incl. M3		
	HD0-0798	129,00	A	E46 series 3 all models incl. M3		
	HD0-0848	115,00	A	E92 series 3		
CITROEN						
	HD0-0863-R	125,00	A	C1	>05	Right
	HD0-0863-L	125,00	A			Left
	HD0-0834-R	129,00	A	C2 / C3	>02	Right
	HD0-0834-L	129,00	A			Left
	HD0-0834-R	129,00	A	DS3	>10	Right
	HD0-0834-L	129,00	A			Left
	HD0-0781-R	115,00	A	SAXO	>96	Right
	HD0-0781-L	115,00	A			Left
DACIA						
	HD0-0885	129,00	A	SANDERO	>08	
FIAT						
	HD0-0871-R	119,00	A	CINQUECENTO	>07	Right
	HD0-0871-L	119,00	A		>07	Left
	HD0-0796	129,00	A	CINQUECENTO/SEICENTO		
	HD0-0782	115,00	A	COUPE'	>93<00	
	HD0-0862-R	146,00	A	GRANDE PUNTO	>10/05	Right
	HD0-0862-L	146,00	A			Left
	HD0-0867-R	136,00	A	PANDA	>9/04	Right
	HD0-0867-L	136,00	A			Left
	HD0-0786-R	163,00	A	PUNTO 1st series	>93<99	Right
	HD0-0786-L	163,00	A			Left
	HD0-0797-R	121,00	A	PUNTO 2nd series	>99<09/05	Right
	HD0-0797-L	121,00	A			Left
	HD0-0740	94,00	A	TIPO	>87<95	
	HD0-0739	121,00	A	UNO	>83<00	
FORD						
	HD0-0778-R	104,00	A	ESCORT/SIERRA COSWORTH		Right
	HD0-0778-L	104,00	A			Left
	HD0-0776	73,00	A	FIESTA 3rd series	>89<95	
	HD0-0793-R	129,00	A	FIESTA 4th series	>96 <02	Right
	HD0-0793-L	129,00	A			Left
	HD0-0845-R	129,00	A	FIESTA 5th series	>05/02<08	Right
	HD0-0845-L	129,00	A			Left
	HD0-0891	153,00	A	FIESTA 6th series	>08	
	HD0-0816-R	136,00	A	FOCUS 3 doors	>99	Right
	HD0-0816-L	136,00	A			Left
	HD0-0853	153,00	A	MUSTANG (seat adaptor)	>78<98	
	HCO-0860	146,00	A	MUSTANG (sliding rail adaptor)	>78<98	
	HD0-0793-R	129,00	A	PUMA	>94>02	Right
	HD0-0793-L	129,00	A			Left
HYUNDAI						
	HD0-0819	136,00	A	COUPE'	>02	

Remark

N = New

NV = Variation

Years

> Major of

< Minor of

R	Ref	Euro		Car	Year	Ref Art
HONDA						
	HD0-0815-R	146,00	A	CIVIC V-TEC Type-R 3 porte	>01<06	Right
	HD0-0815-L	146,00	A			Left
	HD0-0869-R	129,00	A	CIVIC VI Type-R / Type-S	>06	Right
	HD0-0869-L	129,00	A			Left
	HD0-0792-R	121,00	A	INTEGRA	>02	Right
	HD0-0792-L	121,00	A			Left
LANCIA						
	HD0-0773	84,00	A	DELTA 1st series 2.0 integrale	>79<94	
LAND ROVER						
	HD0-0887	154,00	A	Defender 90	>85<90	
MAZDA						
	HD0-0835-R	129,00	A	3	>03	Right
	HD0-0835-L	129,00	A			Left
	HD0-0810-R	129,00	A	MX5 NB (2nd series)	>98<05	Right
	HD0-0810-L	129,00	A			Left
MG						
	HD0-0846-R	146,00	A	ZR	>01	Right
	HD0-0846-L	146,00	A			Left
MINI						
	HD0-0818	136,00	A	1st and 2nd series (R50 R52 R53 R55 R56 R57)	>09/01<13	
MITSUBISHI						
	HD0-0847-R	159,00	A	COLT 3 doors	>06/04	Right
	HD0-0847-L	159,00	A			Left
	HD0-0803-R	129,00	A	LANCER EVO 6		Right
	HD0-0803-L	129,00	A			Left
	HD0-0828-R	104,00	A	LANCER EVO 7 to be welded to body		Right
	HD0-0828-L	104,00	A			Left
	HD0-0877-R	160,00	A	LANCER EVO X		Right
	HD0-0877-L	160,00	A			Left
	HD0-0890-R	171,00	A	PAJERO	<00	Right
	HD0-0890-L	171,00	A		<00	Left
NISSAN						
	HD0-0852-R	183,00	A	PATROL GR	>97	Right
	HD0-0852-L	183,00	A			Left
	HD0-0865-R	167,00	A	Z 350	>03	Right
	HD0-0865-L	167,00	A			Left
OPEL						
	HD0-0737-R	121,00	A	ASTRA F	>91<98	Right
	HD0-0737-L	122,00	A			Left
	HD0-0804	121,00	A	ASTRA G	>98<04	
	HD0-0850	153,00	A	ASTRA H / GTC	>04<06	
	HD0-0785-R	115,00	A	CORSA B	>93<00	Right*
	HD0-0785-L	115,00	A			Left*
	HD0-0841-R	129,00	A	CORSA C	>00<05	Right
	HD0-0841-L	129,00	A			Left
	HD0-0866-R	136,00	A	CORSA D	>06	Right
	HD0-0866-L	136,00	A			Left
	HD0-0737-R	121,00	A	KADETT E	>84<91	Right
	HD0-0737-L	122,00	A			Left
PEUGEOT						
	HD0-0781-R	115,00	A	106	>91	Right
	HD0-0781-L	115,00	A			Left
	HD0-0863-R	125,00	A	107	>05	Right
	HD0-0863-L	125,00	A			Left
	HD0-0735	74,00	A	205	>83<98	
	HD0-0795	139,00	A	206	>98	
	HD0-0870-R	119,00	A	207	>06	Right
	HD0-0870-L	119,00	A			Left
	HD0-0784-R	121,00	A	306	>94	Right
	HD0-0784-L	121,00	A			Left
	HD0-0870-R	119,00	A	307	>00	Right
	HD0-0870-L	119,00	A			Left
	HD0-0870-R	119,00	A	308	>07	Right
	HD0-0870-L	119,00	A			Left
	HD0-0938	136,00	A		>15	
	HD0-0777	115,00	A	309	>86	
PORSCHE						
	HD0-0859-R	146,00	A	911 (996/997)	>09/97	Right
	HD0-0859-L	146,00	A			Left

RENAULT					
HD0-0779-R	115.00	A	CLIO 1th and 2nd series	>90<05	Right
HD0-0779-L	115.00	A			Left
HD0-0873	129.00	A	CLIO 3rd series	>05	
HD0-0742-R	121.00	A	MEGANE 1st series	>95<03	Right
HD0-0742-L	121.00	A		>95<03	Left
HD0-0906	153.00	A	MEGANE 2nd series		
HD0-0892	125.00	A	MEGANE 3rd series saloon	>08	
HD0-0666	115.00	A	R5	>84<90	
HD0-0875-R	129.00	A	TWINGO	>07	Right
HD0-0875-L	129.00	A			Left
ROVER					
HD0-0846-R	146.00	A	25/200	>96	Right
HD0-0846-L	146.00	A			Left
SEAT					
HD0-0780-R	115.00	A	IBIZA 2nd series	>93>02	Right
HD0-0780-L	115.00	A			Left
HD0-0814-R	129.00	A	IBIZA 3rd series	>02	Right
HD0-0814-L	118.00	A			Left
HD0-0838-R	129.00	A	LEON	>09/05	Right
HD0-0838-L	129.00	A			Left
SKODA					
HD0-0814-R	129.00	A	FABIA	>08	Right
HD0-0814-L	118.00	A		>08	Left
SUBARU					
HD0-0813-R	129.00	A	IMPREZA	>12/00	Right
HD0-0813-L	129.00	A			Left
HD0-0825-R	129.00	A	IMPREZA (to be welded to body)	>12/00	Right
HD0-0825-L	129.00	A			Left
HD0-0876-R	153.00	A	IMPREZA WRX STI	>08	Right
HD0-0876-L	154.00	A		>08	Left
SUZUKI					
HD0-0888-R	154.00	A	SAMURAI SANTANA		Right
HD0-0888-L	154.00	A			Left
HD0-0851-R	142.00	A	SWIFT	>05/05	Right
HD0-0851-L	142.00	A			Left
HD0-0889-R	171.00	A	Vitara		Right
HD0-0889-L	171.00	A			Left
TOYOTA					
HD0-0783-R	174.00	A	CELICA GT	<11/99	Right
HD0-0783-L	174.00	A			Left
HD0-0821-R	146.00	A	CELICA	>11/99	Right
HD0-0821-L	146.00	A			Left
HD0-0855	205.00	A	LAND CRUISER	>02	
HD0-0799-R	121.00	A	YARIS	>04/99	Right
HD0-0799-L	121.00	A			Left
HD0-0941-R	136.00	A	YARIS GR	>20	Right
HD0-0941-L	136.00	A			Left
VOLKSWAGEN					
HD0-0738	121.00	A	GOLF 2nd series		
HD0-0780-R	115.00	A	GOLF 3rd series		Right
HD0-0780-L	115.00	A			Left
HD0-0780-R	115.00	A	GOLF 4th series		Right
HD0-0780-L	115.00	A			Left
HD0-0838-R	129.00	A	GOLF 5th series 5 doors	>10/03	Right
HD0-0838-L	129.00	A			Left
HD0-0780-R	115.00	A	LUPO	>98	Right
HD0-0780-L	115.00	A			Left
HD0-0780-R	115.00	A	NEW BEETLE	>98	Right
HD0-0780-L	115.00	A			Left
HD0-0738	121.00	A	POLO 1st series	>10/81 <11/94	
HD0-0780-R	115.00	A	POLO 2ndseries	>11/94<02	Right
HD0-0780-L	115.00	A			Left
HD0-0814-R	129.00	A	POLO 4thseries	>02	Right
HD0-0814-L	118.00	A			Left
HD0-0903	125.00	A	POLO 5th series	>09	
YUGO					
HD0-0808	121.00	A	KORAL	>90<92	
HD0-0838-L	129.00	A			Left
HD0-0838-R	129.00	A			Right

The seats with lower attachments points must be mounted with sliding bracket HC/665

(*) Not for side fixing seats

SAFETY HARNESSSES

Descriptive List

R	Ref	Euro		Description	Colour	Points
SAFETY HARNESSSES (SALOON CARS) FIA 8853-2016						
	DA0-0102-A01	509,00	C	<p>ONE-D 2" PULL DOWN: Ultralightweight and comfortable safety harness for saloon cars in Dyneema®, the strongest fiber in the world™. Forged aluminium ultralight adjusters, buckle in ergal machined from solid and magnesium. The Harness ensures best safety level ever thanks to the ultra-resistant buckle with an anti-unwitting opening system and exclusive double pin T-bar crotch attachments. Adjustable setting of shoulder and lap straps with exclusive F1-inspired "double fold" system for a practical and strong hold. FHR only.</p> <p>Straps dimensions and options:</p> <ul style="list-style-type: none"> -Shoulders: 2" -Lap: 2" pull down -Crotch: 2" <p>Attachments:</p> <ul style="list-style-type: none"> -Shoulders: roll bar -Lap: carabiner -Crotch: snap hook <p>ALSO AVAILABLE IN MAGNESIUM-FREE VERSION UPON REQUEST (DA0-0102-A02)</p>	Black/white (DA0-0102-A01-076)	6
	DA0-0102-A03	509,00	C	<p>ONE-D 2" PULL UP: Ultralightweight and comfortable safety harness for saloon cars in Dyneema®, the strongest fiber in the world™. Forged aluminium ultralight adjusters, buckle in ergal machined from solid and magnesium. The Harness ensures best safety level ever thanks to the ultra-resistant buckle with an anti-unwitting opening system and exclusive double pin T-bar crotch attachments. Adjustable setting of shoulder and lap straps with exclusive F1-inspired "double fold" system for a practical and strong hold. FHR only.</p> <p>Straps dimensions and options:</p> <ul style="list-style-type: none"> -Shoulders: 2" -Lap: 2" pull up -Crotch: 2" <p>Attachments:</p> <ul style="list-style-type: none"> -Shoulders: roll bar -Lap: carabiner -Crotch: snap hook <p>ALSO AVAILABLE IN MAGNESIUM-FREE VERSION UPON REQUEST (DA0-0102-A04)</p>	Black/white (DA0-0102-A03-076)	6
N	DA0-0211-A02	419,00	C	<p>ONE 2" ENDURANCE PULL DOWN: Lightweight and comfortable safety harness for saloon cars in Dyneema and polyester fabric. Forged aluminium ultralight adjusters, quick buckle in ergal machined from solid. FHR only. Quick adjusters. Fluo reflective inserts to best visibility.</p> <p>Straps dimensions and options:</p> <ul style="list-style-type: none"> -Shoulders: 2" -Lap: 2" pull down -Crotch: 2" <p>Attachments:</p> <ul style="list-style-type: none"> -Shoulders: roll bar -Lap: plate -Crotch: plate 	Black (DA0-0211-A02-071)	6
	DA0-0210-A01	359,00	C	<p>ONE 2" WRC PULL UP: Lightweight and comfortable safety harness for saloon cars in polyester fabric. Forged aluminium ultralight adjusters, buckle in ergal machined from solid. The Harness ensures best safety level ever thanks to the ultra-resistant buckle with an anti-unwitting opening system and exclusive double pin T-bar crotch attachments. FHR only.</p> <p>Straps dimensions and options:</p> <ul style="list-style-type: none"> -Shoulders: 2" -Lap: 2" pull up -Crotch: 2" <p>Attachments:</p> <ul style="list-style-type: none"> -Shoulders: roll bar -Lap: carabiner -Crotch: carabiner 	Black (DA0-0210-A01-071)	6

R	Ref	Euro		Description	Colour	Points
N	DA0-0202-A05	359,00	C	<p>ONE 2" VERSA ENDURANCE: Lightweight, comfortable and versatile safety harness for saloon cars in polyester fabric. Forged aluminium ultralight adjusters, buckle in ergal machined from solid and magnesium. The Harness ensures best safety level ever thanks to the ultra-resistant buckle with an anti-unwitting opening system and exclusive double pin T-bar crotch attachments. With quick adjusters on crotch straps, ENDURANCE lap straps pull down. FHR only.</p> <p>Straps dimensions and options:</p> <ul style="list-style-type: none"> -Shoulders: 2" -Lap: 2" pull up endurance -Crotch: 2" <p>Attachments:</p> <ul style="list-style-type: none"> -Shoulders: roll bar/snap hook -Lap: carabiner -Crotch: snap hook 	<p>Red (DA0-0202-A05-061)</p> <p>Black (DA0-0202-A05-071)</p>	6
	DA0-0202-A01	323,00	C	<p>ONE 2" PULL DOWN: Lightweight and comfortable safety harness for saloon cars in polyester fabric. Forged aluminium ultralight adjusters, buckle in ergal machined from solid and magnesium. The Harness ensures best safety level ever thanks to the ultra-resistant buckle with an anti-unwitting opening system and exclusive double pin T-bar crotch attachments. FHR only.</p> <p>Straps dimensions and options:</p> <ul style="list-style-type: none"> -Shoulders: 2" -Lap: 2" pull down -Crotch: 2" <p>Attachments:</p> <ul style="list-style-type: none"> -Shoulders: roll bar -Lap: carabiner -Crotch: snap hook 	<p>Red (DA0-0202-A01-061)</p> <p>Black (DA0-0202-A01-071)</p>	6
	DA0-0202-A02	323,00	C	<p>ONE 2" PULL UP: Lightweight and comfortable safety harness for saloon cars in polyester fabric. Forged aluminium ultralight adjusters, buckle in ergal machined from solid and magnesium. The Harness ensures best safety level ever thanks to the ultra-resistant buckle with an anti-unwitting opening system and exclusive double pin T-bar crotch attachments. FHR only.</p> <p>Straps dimensions and options:</p> <ul style="list-style-type: none"> -Shoulders: 2" -Lap: 2" pull up -Crotch: 2" <p>Attachments:</p> <ul style="list-style-type: none"> -Shoulders: roll bar -Lap: carabiner -Crotch: snap hook 	<p>Red (DA0-0202-A02-061)</p> <p>Black (DA0-0202-A02-071)</p>	6
	DA0-0205-A01	319,00	C	<p>ONE 3+2" CONVERTIBLE: Lightweight and comfortable safety harness for saloon cars in polyester fabric. Ultralightweight aluminium adjuster on shoulders, steel and high strength aluminium lightweight adjusters on lap, buckle in ergal machined from solid and magnesium. The harness ensures best safety level ever thanks to the ultra-resistant buckle with an anti-unwitting opening system and exclusive double pin T-bar crotch attachments. FHR only.</p> <p>Straps dimensions and options:</p> <ul style="list-style-type: none"> -Shoulders: 2"/3" -Lap: 2" pull up (convertible in pull down) -Crotch: 2" <p>Attachments:</p> <ul style="list-style-type: none"> -Shoulders: roll bar -Lap: snap hook -Crotch: snap hook 	<p>Red (DA0-0205-A01-061)</p> <p>Black (DA0-0205-A01-071)</p>	6
	DA0-0205-A02	319,00	C	<p>ONE 3+2" ENDURANCE: Lightweight and comfortable safety harness for saloon cars in polyester fabric. Ultralightweight aluminium adjuster on shoulders, steel and high strength aluminium lightweight adjusters on lap, buckle in ergal machined from solid and magnesium. The harness ensures best safety level ever thanks to the ultra-resistant buckle with an anti-unwitting opening system and exclusive double pin T-bar crotch attachments. FHR only.</p> <p>Straps dimensions and options:</p> <ul style="list-style-type: none"> -Shoulders: 2"/3" -Lap: 2" pull down endurance -Crotch: 2" <p>Attachments:</p> <ul style="list-style-type: none"> -Shoulders: roll bar -Lap: snap hook -Crotch: snap hook 	<p>Red (DA0-0205-A02-061)</p> <p>Black (DA0-0205-A02-071)</p>	6

R	Ref	Euro		Description	Colour	Points
	DA0-0203-A02	255,00	C	<p>TECNICA 3+2": Lightweight and comfortable safety harness for saloon cars in polyester fabric. Steel and high strength aluminium lightweight adjusters, buckle in ergal machined from solid and magnesium. The harness ensures best safety level ever thanks to the ultra-resistant buckle with an anti-unwitting opening system and exclusive double pin T-bar crotch attachments. FHR only.</p> <p>Straps dimensions and options:</p> <ul style="list-style-type: none"> -Shoulders: 2/3" -Lap: 3" pull up -Crotch: 2" <p>Attachments:</p> <ul style="list-style-type: none"> -Shoulders: roll bar -Lap: carabiner -Crotch: snap hook 	<p>Red (DA0-0203-A02-061)</p> <p>Black (DA0-0203-A02-071)</p>	6
	DA0-0203-A01	255,00	C	<p>TECNICA 3": Lightweight and comfortable safety harness in polyester fabric for saloon cars. Steel and high strength aluminium lightweight adjusters, buckle in ergal machined from solid and magnesium. The harness ensures best safety level ever thanks to the ultra-resistant buckle with an anti-unwitting opening system and exclusive double pin T-bar crotch attachments. FHR friendly.</p> <p>Straps dimensions and options:</p> <ul style="list-style-type: none"> -Shoulders: 3" -Lap: 3" pull up -Crotch: 2" <p>Attachments:</p> <ul style="list-style-type: none"> -Shoulders: snap hook or roll bar -Lap: carabiner -Crotch: snap hook 	<p>Red (DA0-0203-A01-061)</p> <p>Black (DA0-0203-A01-071)</p>	6
	DA0-0204-B01	207,00	C	<p>FIRST 3": Lightweight and comfortable safety harness for saloon cars in polyester fabric. Strong steel adjusters, buckle in aluminium and steel with an improved quality/price ratio that ensures same quality at lower price. FHR friendly.</p> <p>Straps dimensions and options:</p> <ul style="list-style-type: none"> -Shoulders: 3" -Lap: 3" pull up -Crotch: 2" <p>Attachments:</p> <ul style="list-style-type: none"> -Shoulders: snap hook or roll bar -Lap: snap hook -Crotch: snap hook 	<p>Red (DA0-0204-B01-061)</p> <p>Black (DA0-0204-B01-071)</p>	6
	DA0-0204-B02	197,00	C	<p>FIRST 3+2": Lightweight and comfortable safety harness for saloon cars in polyester fabric. Strong steel adjusters, buckle in aluminium and steel with an improved quality/price ratio that ensures same quality at lower price. FHR only.</p> <p>Straps dimensions and options:</p> <ul style="list-style-type: none"> -Shoulders: 2/3" -Lap: 3" pull up -Crotch: 2" <p>Attachments:</p> <ul style="list-style-type: none"> -Shoulders: snap hook or roll bar -Lap: snap hook -Crotch: snap hook 	<p>Red (DA0-0204-B02-061)</p> <p>Black (DA0-0204-B02-071)</p> <p>Blue (DA0-0204-B02-041)</p> <p>Black/fluo yellow (DA0-0204-B02-178)</p>	6
	DA0-0208-A01	187,00	C	<p>FIRST 2": Lightweight and comfortable entry level safety harness in polyester fabric for saloon cars. Steel adjusters on lap, steel and aluminium adjusters on shoulder, buckle in aluminium and steel with an improved quality/price ratio that ensures same quality at lower price. FHR only.</p> <p>Straps dimensions and options:</p> <ul style="list-style-type: none"> -Shoulders: 2" -Lap: 2" pull up -Crotch: 2" <p>Attachments:</p> <ul style="list-style-type: none"> -Shoulders: snap hook -Lap: snap hook -Crotch: snap hook 	<p>Red (DA0-0208-A01-061)</p> <p>Black (DA0-0208-A01-071)</p>	6
SAFETY HARNESES (FORMULA CARS) FIA 8853-2016						
	DA0-0104-A01	509,00	C	<p>ONE-D 2" FORMULA: Ultralightweight and comfortable safety harness for Formula cars in Dyneema®, the strongest fiber in the world™. Forged aluminium ultralight adjusters, buckle in ergal machined from solid and magnesium. The Harness ensures best safety level ever thanks to the ultra-resistant buckle with an anti-unwitting opening system. Adjustable setting of shoulder and lap straps with exclusive F1-inspired "double fold" system for a practical and strong hold. FHR only.</p> <p>Straps dimensions and options:</p> <ul style="list-style-type: none"> -Shoulders: 2" -Lap: 2" -Crotch: 2" <p>Attacco scocca:</p> <ul style="list-style-type: none"> -Shoulders: sewn webbing -Lap: plate -Crotch: plate 	<p>Black/white (DA0-0104-A01-076)</p>	6

R	Ref	Euro		Description	Colour	Points
	DA0-0102-A05	509,00	C	ONE-D 2" PROTOTYPE: Ultralightweight and comfortable safety harness for prototype cars in Dyneema®, the strongest fiber in the world™. Forged aluminium ultralight adjusters, buckle in ergal machined from solid and magnesium. The harness ensures best safety level ever, thanks to the ultra-resistant buckle with an anti-unwitting opening system and exclusive double pin T-bar crotch attachments. Adjustable setting of shoulder and lap straps with exclusive F1-inspired "double fold" system for a practical and strong hold. FHR only. Straps dimensions and options: -Shoulders: 2" -Lap: 2" -Crotch: 2" pull up Attachments: -Shoulders: sewn webbing -Lap: plate -Crotch: plate	Black/white (DA0-0102-A05-076)	6
	DA0-0206-A01	265,00	C	TECNICA 2" FORMULA: Lightweight and comfortable safety harness for formula cars in polyester fabric. Forged aluminium ultralight adjusters, buckle in ergal machined from solid and magnesium. The Harness ensures best safety level ever thanks to the ultra-resistant buckle with an anti-unwitting opening system and exclusive double pin T-bar crotch attachments. FHR only. Straps dimensions and options: -Shoulders: 2" -Lap: 2" pull up -Crotch: 2" Attachments: -Shoulders: sewn webbing -Lap: plate -Crotch: plate	Red (DA0-0206-A01-061) Black (DA0-0206-A01-071)	6
	DA0-0206-A02	265,00	C	TECNICA 2" PROTOTYPE: Lightweight and comfortable safety harness for formula cars in polyester fabric. Forged aluminium ultralight adjusters, buckle in ergal machined from solid and magnesium. The Harness ensures best safety level ever thanks to the ultra-resistant buckle with an anti-unwitting opening system and exclusive double pin T-bar crotch attachments. FHR only. Straps dimensions and options: -Shoulders: 2" -Lap: 2" pull up -Crotch: 2" Attachments: -Shoulders: plate -Lap: plate -Crotch: plate	Red (DA0-0206-A02-061) Black (DA0-0206-A02-071)	6
SAFETY HARNESES (SALOON CARS) FIA 8854/98						
	DA0-0801-B01	177,00	C	FIRST 3" 4P: 4 point safety harnesses for saloon, 3" straps. Ultralightweight adjuster, homologated for roll bar, steel snap hook, lap strap buckle fixed. FIA 8854/98 homologation.	Red (DA0-0801-B01-061) Black (DA0-0801-B01-071)	4
SAFETY HARNESES ECE HOMOLOGATED						
	DA0-0508-A01	145,00	A	ROAD 4M: 4 point harness, 3" shoulder straps with racing steel adjusters, and 2" lap belts, snap hook attachment. Central push button release. Waist load spreader pad. Supplied with 7/16" eyebolts. ECE homologated	Blue (DA0-508-A01-041) Black (DA0-508-A01-071) Red (DA0-508-A01-061)	4
	DA0-0507-A01	119,00	A	ROAD 4M: 4 point harness, 2" shoulder straps and lap belts, bolt in attachment. Central push button release. Supplied with 7/16" bolts.	Blue (DA0-507-A01-041) Black (DA0-507-A01-071) Red (DA0-507-A01-061)	4
	DA0-0509-A01	115,00	A	STRADA 3: 3 point harness, 2" shoulder straps and lap belts, bolt in attachment. Double push button release to facilitate rear seat access. Supplied with 7/16" bolts.	Black (DA0-509-A01-071) Red (DA0-509-A01-061)	3
	DA0-0504-A01	109,00	A	ROAD 3: 3 point harness, 2" shoulder straps and lap belts, snap hook attachment. Central push button release. Supplied with 7/16" bolts.	Blue (DA0-504-A01-041) Black (DA0-504-A01-071) Red (DA0-504-A01-061)	3
	DA0-0505-A01	109,00	A	ROAD 4: 4 point harness, 2" shoulder straps and lap belts, bolt in attachment. Central push button release. Supplied with 7/16" bolts.	Blue (DA0-505-A01-041) Black	4
	DB0-0450-A01	21,00	A	Pair of harness pads in velour to be used with 2" seat belts, velcro fastening.	Red (DB0-0450-A01-061) Black (DB0-0450-A01-071) Blue (DB0-0450-A01-041)	

R	Ref	Euro		Description	Colour	Points
	XMD-437	75,00	C	Conveyor for harness tongue. Accelerates the entrance of the harness into the buckle; ideal for endurance competitions with drivers exchange. Available on request.	Black Red (for minimum orders of 50 pieces)	
	DB0-0460-B01	23,00	C	Professional safety belt cutter with hammer, light, emergency lamp and magnet. YELLOW COLOURED.	Yellow (DB0-0460-B01)	
	DB0-0461	11,20	C	Safety seat belt cut.		
	DB0-0418-A01	8,00	C	Seat belt plate with threaded 7/16" nut ready to be welded to the chassis. Complying with FIA.		
	DB0-0459	7,00	C	Safety seat belt cutter.		
	DB0-0420-A01	4,50	C	7/16" eyebolt to attach harness snap-hook fittings. Eyebolts must be ordered separately. Complying with FIA.		
	DB0-0421-A01	3,30	C	Reinforced threaded plate for eyebolts DB/420.		
SEAT BELT PADS						
	DB0-0455	60,00	A	Pair of harness pads in fire retardant Nomex to be used with 2" seat belts. Zipper quick closure, antislip silicon rubber inserts in shoulders contact area. Compatible with Hybrid® safety device.	Black (DB0-0455-071)	
	DB0-0450-A02	30,00	A	Pair of 3" seat belt pads in light padded velour with vertical "OMP" logos and velcro closure. Intended for 76mm (3inch) harnesses.	Red (DB0-0450-A02-061) Blue (DB0-0450-A02-041) Black (DB0-0450-A02-071)	
	DB0-0450-A01	21,00	A	Pair of harness pads in velour to be used with 2" seat belts, velcro fastening.	Red (DB0-0450-A01-061) Black (DB0-0450-A01-071) Blue (DB0-0450-A01-041)	

RACING ROLL CAGES

Application List

R	Ref	Euro	Car	Version	Year	Fix Point	Mat	Feat.	Kg	Hom	
ALFA ROMEO											
	AA0-104P-1	863,00	C	33	>72<94	6 b	Fe45	A2SX	30	FIA-ALL J	
	AA0-104P-8	868,00	C	75	>85<92	6 b	Fe45	A2SX	30	FIA-ALL J	
	AA0-0104-8S	1,250,00	C		>85<92	8 b	Fe45	A2CDS	35	FIA-ALL J	
	AB0-105P-13	786,00	C	145	>94<01	10 b	Fe45	A2X	26.5	FIA-ALL J	
	AB0-105P-204	786,00	C	146	>94<01	10 b	Fe45	A2EX	27	FIA-ALL J	
	AB0-0105-222A	922,00	C	147	>01	MP-w	Fe45	A2B	38	FIA-ALL J	
	AB0-0106-12A	2,160,00	C	155	>92<97	MP-w	Cr-Mo	A1BCDEFGJKLQ	38	ONS	
	AB0-0105-203AH	1,170,00	C	156	>97	MP-w	Fe45	A2BCDNV2U	46	FIA-ALL J	
	AB0-0106-203A	1,616,00	C		>97	MP-w	Cr-Mo	A1BCDEFGH2IKLQ	37	RAC	
	AA0-104P-7	868,00	C	1750	Saloon	>68<72	6 b	Fe45	A2SX	30	FIA-ALL J
	AA0-104P-3	868,00	C	1900	(old model)	>50<59	6 b	Fe45	A2SX	33	FIA-ALL J
	AA0-104P-6	868,00	C	ALFASUD	Sprint	>76<89	6 b	Fe45	A2SX		FIA-ALL J
	AA0-104P-1	863,00	C		Saloon	>72<84	6 b	Fe45	A2SX	30	FIA-ALL J
	AA0-104P-5	868,00	C	ALFETTA	GTV (old model)	>78<87	6 b	Fe45	A2SX	27	FIA-ALL J
	AA0-104P-9	868,00	C	GIULIA	Saloon 4 doors	>64<78	6 b	Fe45	A2SX	32	FIA-ALL J
	AA0-104P-4	868,00	C	GIULIETTA	Saloon (old model)	>53<63	6 b	Fe45	A2SX	31	FIA-ALL J
	AB0-0100-2	877,00	C	GT GTA	2 doors (old model)	>63<76	6 b	Fe45	A2SX	27	FIA-ALL J
	AB0-0100-2S	1,488,00	C			>63<76	6 b	Fe45	A1BJNRS	35	FIA-ALL J
	AB0-105P-212	786,00	C	GTV	3.0 V6	>94	8 b	Fe45	A2EX	27	FIA-ALL J
	AB0-0100-334	1,533,00	C	MITO		>06/08	6 b	Fe45	A1EH2NRSV2U	47	FIA-ALL J
AUDI											
	AB0-105P-289	874,00	C	QUATTRO		>80<91	6 b	Fe45	A2SX		FIA-ALL J
AUTOBIANCHI											
	AA0-104P-10	942,00	C	A112		>78<86	6 b	Fe45	A2EH2SX	29	FIA-ALL J
BMW											
	AB0-105P-340	786,00	C	1602/2002		>62<72	6 b	Fe45	A2SX	30	FIA-ALL J
	AB0-0100-248	1,250,00	C	SERIES 1	E87 4 doors	>09/04	10 b	Fe45	A2EGNOX		FIA-ALL J
	AA0-104P-16	868,00	C	SERIES 3 E21	320/ 320I/ 323 2 doors	>75<83	6 b	Fe45	A2SX	30	NO FIA
	AB0-0100-17	868,00	C	SERIES 3 E30	2 doors with sunroof	>83<91	6 b	Fe45	A2ESX	31	FIA-ALL J
	AB0-0106-17B	1,936,00	C		2 doors	>83<91	MP-b	Cr-Mo	A1BCDEFGHIJKQS	36	ONS
	AB0-0106-17A	1,883,00	C		2 doors	>83<91	MP-w	Cr-Mo	A1BCDEFGHIJK	34	ONS
	AB0-0106-17AW	1,618,00	C		2 doors	>83<91	MP-w-w	Cr-Mo	A1BCDEFGHIJK	34	ONS
	AB0-0106-18A	2,066,00	C	SERIES 3 E36	Coupè	>92	MP-w	Cr-Mo	A1BCDEFGHIJKL	43	ONS
	AB0-0106-19A	1,714,00	C		Compact	>94	MP-w	Cr-Mo	A1BCDEFGHIJKLQ	41	ONS
	AB0-105P-291	786,00	C		M3 Coupè 2 doors	>90<01	6 b	Fe45	A2ESX	23,5	FIA-ALL J
	AB0-0105-218ASH	1,220,00	C	SERIES 3 E46	320 4 doors ***	>00<04	MP-w	Fe45	A2BN	51	FIA-ALL J
	AB0-0105-218AH	1,122,00	C		320 4 doors ***	>00<04	MP-w	Fe45	A2BN	43	FIA-ALL J
	AB0-0100-269A	1,929,00	C	SERIES 3 E90	M3 4 doors	>08	6 b	Fe45	A1EH1NOX	50	FIA-ALL J
	AB0-0100-340A	1,916,00	C	SERIE 3 E92	M3 2 doors	>06	MP-w	Fe45	A1BCEH1KNRUV2	57	FIA-ALL J
	AB0-0100-237A	1,413,00	C	SERIES 5 E39	4 doors	>95<03	10 w	Fe45	A1BCEH1NZ	58	FIA-ALL J
CAN-AM											
	AB0-0100-345	2,162,00	C	COMMANDER 800/1000 X		>01/12	8 w	Fe45	A3CH3KNORZ	53	NO FIA
	AB0-0100-349	2,275,00	C	MAVERICK	1000	2014	8 w	Fe45	A3CH3KNRV2UZ	55	FIA-ALL J
	AB0-0100-349T	2,414,00	C			2014	8 w	Fe45	A3CH3KNRV2UZ + TETTO	65	FIA-ALL J
CITROEN											
	AB0-105P-23	786,00	C	AX	3 doors	>86<98	8 b	Fe45	A2SX	31	NO FIA
	AA0-104P-22	868,00	C	BX		>82<93	6 b	Fe45	A2SX		NO FIA
	AB0-0100-253	1,312,00	C	C2		>03	10 b	Fe45	A2ENOX	41	FIA-ALL J
	AB0-0106-253A	2,281,00	C	C2 A/N 5672		>03	MP-w	Cr-Mo	A1CEH1KNORQ	47	RAC
	AB0-0100-270A	2,003,00	C	C4	Coupé	>04	MP-w	Fe45	A1BCEH1NV2U	45	FIA-ALL J
	AB0-0100-337	1,946,00	C	DS3	3 doors	>10	6 b	Fe45	A1CEH3NRSV2U	60	FIA-ALL J
	AB0-0100-337A	2,008,00	C		3 doors	>10	MP-w	Fe45	A1CEH3NRSV2U		FIA-ALL J
	AB0-105P-182	786,00	C	SAXO		>96	10 b	Fe45	A2ESX	30	FIA-ALL J
	AB0-0105-182A	906,00	C			>96	MP-w	Fe45	A2BCEX	38	RAC
	AB0-0106-182A	1,536,00	C			>96	MP-w	Cr-Mo	A2BCDEKLQ	38	RAC
	AB0-0106-182AW	1,441,00	C			>96	MP-w-w	Cr-Mo	A2BCDEKLQ	38	RAC
	AB0-105P-21	786,00	C	VISA		>78<91	6 b	Fe45	A2SX	32	FIA-ALL J
	AB0-105P-209H	1,016,00	C	XSARA		>97	10 b	Fe45	A2NX	37	NO FIA
	AB0-0106-209A	1,995,00	C			>97	MP-w	Cr-Mo	A1BCEH2JKLQ	50	RAC
	AB0-105P-24	786,00	C	ZX	3 doors	>91<97	10 b	Fe45	A2	31	ONS
	AB0-0106-24A	2,015,00	C		3 doors	>91<97	MP-w	Cr-Mo	A1BCDEFGH1JKLQ	36	ONS
DACIA											
	AB0-0100-276	1,675,00	C	SANDERO		>08	6 b	Fe45	A1EH2NRSV2U	49	FIA-ALL J

R	Ref	Euro	Car	Version	Year	Fix Point	Mat	Feat.	Kg	Hom	
DAEWOO											
	AB0-105P-207	786,00	C	LANOS	1.6 16V SX	>97	10 b	Fe45	A2EX	25	FIA-ALL J
FIAT											
	AB0-105P-272	907,00	C	124	Spider Abarth Rally	>72<76	6 b	Fe45	A2SX	30	FIA-ALL J
	AB0-105P-292	916,00	C		Saloon	>66<74	6 b	Fe45	A2SX	25	FIA-ALL J
	AA0-104P-29	868,00	C	126		>72<00	6 b	Fe45	A2SX		FIA-ALL J
	AA0-104P-32	868,00	C	127	903 cc./ 1050 cc.	>71<86	6 b	Fe45	A2SX	29	FIA-ALL J
	AA0-104P-34	868,00	C	128	Saloon 4 doors	>69<84	6 b	Fe45	A2SX	30	FIA-ALL J
	AA0-104P-35	863,00	C		Saloon 2 doors	>69<84	6 b	Fe45	A2SX	30	FIA-ALL J
	AA0-104P-36	868,00	C		Coupè 3 doors	>72<81	6 b	Fe45	A2SX		FIA-ALL J
	AB0-105P-265	848,00	C	131	2 doors	>74<86	6 b	Fe45	A2SX	30	FIA-ALL J
	AB0-0100-28	868,00	C	500		>57<76	6 b	Fe45	A2SX	28	FIA-ALL J
	AB0-0100-267	1,527,00	C			>2007	6 b	Fe45	A1BEH1NRSV2U	30	FIA-ALL J
	AA0-104P-30	868,00	C	600	Abarth 850/ 1000	>55<71	6 b	Fe45	A2SX	28	FIA-ALL J
	AB0-105P-301	916,00	C	2300 S	Coupè	>61<68	6 b	Fe45	A2SX	22	FIA-ALL J
	AB0-105P-214	786,00	C	CINQUECENTO	Sporting	>91<98	8 b	Fe45	A2SX	27	FIA-ALL J
	AB0-105P-51	786,00	C	COUPÈ		>93	10 b	Fe45	A2ESX	27	FIA-ALL J
	AB0-0100-333	1,498,00	C	GRANDE PUNTO	3/5 doors		6 b	Fe45	A1EH2NRSV2U	45	FIA-ALL J
	AA0-104P-46	868,00	C	PANDA 1st series	30/ 45/ 4x4	>80<02	6 b	Fe45	A2SX	31	NO FIA
	AB0-0100-258A	2,289,00	C	PANDA 2nd series	4X4	>09/03<12	MP-W	Fe45	A1BEH2KNUV2RS	60	FIA-ALL J
	AB0-0100-273	1,158,00	C		4 doors	>09/03<12	6 b	Fe45	A1EH2NRS	50	FIA-ALL J
	AB0-105P-50	867,00	C	PUNTO 2nd series	3 doors	>09/99	10 b	Fe45	A2EX	27	FIA-ALL J
	AB0-105P-50RS	1,091,00	C		3 doors RACING START	>09/99	6 b	Fe45	A2ENRSV2U		FIA-ALL J / RACING START
	AB0-0105-50AS	2,008,00	C		3 doors	>09/99	MP-w	Fe45	A2BCEFGH2KLQR	58	RAC
	AB0-0100-333	1,498,00	C	PUNTO EVO	3/5 doors		6 b	Fe45	A1EH2NRSV2U	45	FIA-ALL J
	AA0-104P-48	868,00	C	RITMO		>78<88	6 b	Fe45	A2TX	30	ONS
	AB0-105P-49	786,00	C	TIPO	5 doors	>87<95	8 b	Fe45	A2X	27	NO FIA
	AB0-0106-49B	1,939,00	C		5 doors	>87<95	MP-b	Cr-Mo	A2BCEFGHI	34	ONS
	AB0-0106-49A	1,615,00	C		5 doors	>87<95	MP-b	Cr-Mo	A2BCEFGHI	30	ONS
	AB0-105P-214	786,00	C	SEICENTO		>98<2010	8 b	Fe45	A2SX	27	FIA-ALL J
	AB0-0106-214	1,115,00	C			>98<2010	MP-b	Cr-Mo	A2BGH2LX	28	RAC
	AB0-105P-227H	1,030,00	C	STILO	3 doors	>10/01	8 b	Fe45	A2ENX	40	FIA-ALL J
	AA0-104P-47	868,00	C	UNO	45/70	>83<93	6 b	Fe45	A2ESX	30	FIA-ALL J
	AA0-104P-43	868,00	C	X1/9		>72<89	6 b	Fe45	A2SX	25	FIA-ALL J
FORD											
	AB0-105P-304	786,00	C	CAPRI		>69<73	6 b	Fe45	A2SX	22	FIA-ALL J
	AB0-105P-305	840,00	C	CORTINA		>62<70	6 b	Fe45	A2SX	24,5	FIA-ALL J
	AB0-105P-306	786,00	C	ESCORT	MK 1	>68<75	6 b	Fe45	A2SX	23,4	FIA-ALL J
	AB0-105P-307	786,00	C		MK 2	>75<80	6 b	Fe45	A2SX	28,4	FIA-ALL J
	AB0-105P-308	786,00	C		RS Turbo (MK3b/MK4)	>86<89	6 b	Fe45	A2SX	24,9	FIA-ALL J
	AB0-105P-308	786,00	C		XR3/ RS Turbo/ MK 3/4 with sunroof	>86<90	6 b	Fe45	A2SX	24,9	FIA-ALL J
	AB0-0105-68A	1,063,00	C		Cosworth	>92	MP-w	Fe45	A2BCX	38	FIA-ALL J
	AB0-0106-68B	2,348,00	C		Cosworth	>92	MP-b	Cr-Mo	A2BCDEFGH1H3JLSXZ	48	ONS
	AB0-0106-68A	2,266,00	C		Cosworth	>92	MP-w	Cr-Mo	A1BCDEGH1JLKLX	39,5	ONS
	AA0-104P-60	868,00	C	FIESTA 2nd series		>83<89	6 b	Fe45	A2SX	29	FIA-ALL J
	AB0-105P-67	786,00	C	FIESTA 3rd series	XR2i 3 doors	>89<95	10 b	Fe45	A2SX	27	FIA-ALL J
	AB0-105P-210H	1,204,00	C	FIESTA 4th series	3 doors	>95<02	10 b	Fe45	A2NSV2U	35	FIA-ALL J
	AB0-0100-355	1,423,00	C	FIESTA 5th series	3 doors	>02<08	6 b	Fe45	A1EH2NRSV2U		FIA-ALL J
	AB0-0100-338	1,387,00	C	FIESTA 6th series	3 doors	>08	6 b	Fe45	A1ENRSUV2	50	FIA-ALL J
	AB0-0100-338A	1,318,00	C		3 doors	>08	6 w	Fe45	A1EKNRSUV2	48	FIA-ALL J
	AB0-105P-259H	1,183,00	C	FOCUS	3 doors	>98<04	10 b	Fe45	A2NSV2U	37	FIA-ALL J
	AB0-105P-309	786,00	C	KA 1st series		>96<08	6 b	Fe45	A2SX	24	FIA-ALL J
	AB0-0106-65	2,039,00	C	SIERRA	Cosworth 2 doors	>87<93	MP-b	Cr-Mo	A3BCDEFGH1H3	46	ONS
	AB0-0106-664A	2,340,00	C		Cosworth 4 doors / 4X4	>87<93	MP-w	Cr-Mo	A2BCDEFGH1IKL	32	ONS
	AB0-105P-311	786,00	C		Cosworth 2 doors	>85<87	6 b	Fe45	A2SX	23,6	FIA-ALL J
HONDA											
	AB0-105P-56	786,00	C	CIVIC	3 doors	<91	10 b	Fe45	A2SX	27	FIA-ALL J
	AB0-105P-57	786,00	C	CIVIC 5th series - EG6	3 doors	>92<95	10 b	Fe45	A2EX	27	FIA-ALL J
	AB0-105P-313	786,00	C	CIVIC 6th series	3 doors	>95<01	6 b	Fe45	A2ESX	23,6	FIA-ALL J
	AB0-105P-313RS	1,091,00	C		RACING START	>95<01	6 b	Fe45	A2ENRSV2U		FIA-ALL J / RACING START
	AB0-0106-236A	1,998,00	C	CIVIC 7th series	3 doors	>09/01<06	MP-w	Cr-Mo	A2BCDEFH2KLNORX	47	RAC
	AB0-0106-229A	2,291,00	C		3 doors	>09/01<06	MP-w	Cr-Mo	A1BCDEFH2JLNPQ	47	RAC
	AB0-105P-314	786,00	C		Type R	>01<06	6 b	Fe45	A2ESX	24,5	FIA-ALL J
	AB0-0106-263A	2,623,00	C	CIVIC 8th series (A/N5710 - A/N5716)	Type R FN2 - FD2 (no FK2)	>06	Mp-w	Cr-Mo	A1BCDEGH1KLNORX	57	RAC/MSA

R	Ref	Euro	Car	Version	Year	Fix Point	Mat	Feat.	Kg	Hom	
	AB0-105P-206	786,00	C	INTEGRA	1.8 16V	>96<01	10 b	Fe45	A2ESX	27	FIA-ALL J
INNOCENTI											
	AB0-105P-224	867,00	C	YUGO KORAL 55		>90<93	10 b	Fe45	A2SX	25	FIA-ALL J
JAGUAR											
	AB0-0100-238A	1,436,00	C	S TYPE		>99	10 w	Fe45	A1BCEH2NXZ		FIA-ALL J
	AB0-105P-316	980,00	C	E TYPE			6 b	Fe45	A2ESX	20,4	FIA-ALL J
LANCIA											
	AB0-105P-317	786,00	C	BETA	Coupè	>73<84	6 b	Fe45	A2ESX	21,5	FIA-ALL J
	AB0-105P-318	786,00	C		Montecarlo	>75<82	6 b	Fe45	A2SX	20,3	FIA-ALL J
	AA0-104P-86	868,00	C	DELTA 1st series	HF-4WD-INT. 1.6V	>79<94	6 b	Fe45	A2ESX	29	FIA-ALL J
	AB0-0106-86B	1,630,00	C		HF-4WD-INT. 1.6V	>79<94	MP-b	Cr-Mo	A2BCDEFGQS	32	ONS
	AB0-0106-86A	1,618,00	C		HF-4WD-INT. 1.6V	>79<94	MP-w	Cr-Mo	A2BCDEFGQ	29	ONS
	AA0-104P-80	868,00	C	FULVIA	Coupè HF "fanalone"	>68<75	6 b	Fe45	A2SX	27	FIA-ALL J
	AB0-105P-81	786,00	C		Coupè Montecarlo	>68<75	6 b	Fe45	A2SX		FIA-ALL J
LEYLAND											
	AA0-104P-70	868,00	C	MINI	MK II / MINI Cooper	>67<69	6 b	Fe45	A2SX	30	FIA-ALL J
MAZDA											
	AB0-0105-74S	1,310,00	C	323	3 doors (BG_chassis)	>90<96	MP-b	Fe45	A2BC	40	NO FIA
	AB0-105P-74	786,00	C		3 doors (BG_chassis)	>90<96	10 b	Fe45	A2SX	27	NO FIA
	AB0-105P-225	786,00	C	MX5 2nd series **	NB	>98<05	10 b	Fe45	A2SX	27	NO FIA
	AB0-0100-240A	1,816,00	C	RX8		>10/03	10 w	Fe45	A1BCDENJQR		FIA-ALL J
MG/ROVER											
	AB0-0100-246	1,058,00	C	25/200		>95	10 b	Fe45	A2EGNX	28	FIA-ALL J
	AB0-0100-246	1,058,00	C	105 ZR		>01	10 b	Fe45	A2EGNX	28	FIA-ALL J
	AB0-0100-246RS	1,117,00	C	105 ZR / 25 / 200	RACING START		6 b	Fe45	A2ENRSV2U		FIA-ALL J / RACING START
	AB0-0105-213AS	1,043,00	C	MGF		>95<02	10 b	Fe45	A2GJX	28	RAC
MINI											
	AB0-0100-243	1,660,00	C	Mini	1st and 2nd series (R50 R52 R53 R55 R56 R57)	>01	6 b	Fe45	A1EH2NRSV2XU	52	FIA-ALL J
	AB0-0106-243A	2,258,00	C	ONE-COOPER		>03/01	MP-w	Cr-Mo	A1BCEH2NOQR	47	RAC
MITSUBISHI											
	AB0-105P-319	786,00	C	LANCER	EVO IV / V / VI	>96<00	6 b	Fe45	A2SX	26	FIA-ALL J
	AB0-0106-211A	1,965,00	C		EVO IV / V / VI	>96<00	MP-w	Cr-Mo	A1BCDEFGH1H2IKLQ	38	RAC
	AB0-0106-235A	2,068,00	C	LANCER/CARISMA	EVO VII / VIII / VIII MR	>01<04	MP-w	Cr-Mo	A1BCDEFGH1IKLNOR	43	RAC
	AB0-0106-235AW	1,725,00	C		EVO VII / VIII / VIII MR	>01<04	MP-w-w	Cr-Mo	A1BCDEFGH1IKLNOR	43	RAC
	AB0-0106-252A	2,098,00	C	LANCER/CARISMA	EVO IX A/N 5688	>06	MP-w	Cr-Mo	A1BCDEFGH1IKLNOR	53	RAC
	AB0-0106-252AW	1,831,00	C		EVO IX A/N 5688	>06	MP-w-w	Cr-Mo	A1BCDEFGH1IKLNOR	53	RAC
	AB0-0106-262A	3,029,00	C	LANCER/CARISMA	EVO X A/N 5718	>07	MP-w	Cr-Mo	A1BCDEGH1KLNORXZ	63	RAC
	AB0-0106-262AW	2,391,00	C		EVO X A/N 5718	>07	MP-w-w	Cr-Mo	A1BCDEGH1KLNORXZ	63	RAC
NISSAN											
	AB0-0100-257A	2,220,00	C	350 Z		> 04	MP-w	Fe45	A1CEH1NRV2U		FIA-ALL J
	AA0-104P-76	868,00	C	MICRA 2nd series		>08/92<12/02	10 b	Fe45	A2SX	29	FIA-ALL J
	AB0-0100-234	1,048,00	C	MICRA 2nd series	3 doors	>03<10	10 b	Fe45	A2EFGH2N	34	FIA-ALL J
	AB0-0100-354	1,206,00	C	SILVIA	S14	>93<00	6 b	Fe45	A1H1ENRSV2U		FIA-ALL J
	AB0-0100-354A	1,304,00	C			>93<00	6 w	Fe45	A1H1ENRSV2U		FIA-ALL J
	AB0-0106-77A	1,658,00	C	SUNNY	2.0 4WD GTI-R		MP-w	Cr-Mo	A1BCDEFGH1JLQ	32	ONS
OPEL											
	AA0-104P-93	868,00	C	ASCONA	B/400	<78	6 b	Fe45	A2SX		FIA-ALL J
	AB0-105P-98	786,00	C	ASTRA F	3 doors	>91	10 b	Fe45	A2SX	27	FIA-ALL J
	AB0-0106-98B	1,851,00	C		3 doors	>91	MP-b	Cr-Mo	A2BCDEFGH1IKLQS	34	ONS
	AB0-0106-98A	1,866,00	C		3 doors	>91	MP-w	Cr-Mo	A2BCDEFGH1IKLQ	32	ONS
	AB0-0106-223A	1,999,00	C	ASTRA G	3 doors	>98	MP-w	Cr-Mo	A1BCDEFGH2JLKQ	42,5	RAC
	AB0-105P-223	867,00	C			>98	10 b	Fe45	A2EX	26	FIA-ALL J
	AA0-104P-97	868,00	C	CORSA A		<92	6 b	Fe45	A2ESX	29	FIA-ALL J
	AB0-105P-99	786,00	C	CORSA B	3 doors	>93	10 b	Fe45	A2SX	27	FIA-ALL J
	AB0-0100-342	1,521,00	C	CORSA D	3 doors	>06	6 b	Fe45	A1EH2NRSV2U	50	FIA-ALL J
	AA0-104P-91	868,00	C	KADETT C	1.9 GTE/ 2.0 GTE	<79	6 b	Fe45	A2SX	28	FIA-ALL J
	AA0-104P-94	868,00	C	KADETT D		>79<84	6 b	Fe45	A2SX	30	NO FIA
	AA0-104P-96	868,00	C	KADETT E	3 doors	>84<91	6 b	Fe45	A2ESX	30	FIA-ALL J
	AB0-0106-96	1,894,00	C		3 doors	>84<91	MP-b	Cr-Mo	A2BCDEFGH1IQS	27,5	ONS
	AA0-104P-95	868,00	C	MANTA	B	>75<88	6 b	Fe45	A2SX	29	FIA-ALL J
PEUGEOT											
	AB0-105P-125	907,00	C	104	ZS Coupè	>78<88	6 b	Fe45	A2DSX	30	FIA-ALL J
	AB0-0106-129B	1,623,00	C	106	3 doors	>91	MP-b	Cr-Mo	A2BCDEFGILQS	27	ONS
	AB0-0106-129AE	972,00	C		3 doors	>91	MP-w	Cr-Mo	A2BCEFGIK	27	ONS
	AB0-0106-129AEW	648,00	C		3 doors	>91	MP-w-w	Cr-Mo	A2BCEFGIK	27	ONS
	AB0-105P-182	786,00	C		3 doors	>91	10 b	Fe45	A2ESX	30	FIA-ALL J

R	Ref	Euro	Car	Version	Year	Fix Point	Mat	Feat.	Kg	Hom	
	ABO-105P-182RS	1,091,00	C		RACING START	>91	6 b	Fe45	A2ENRSV2U	42	FIA-ALL J / RACING START
	ABO-0105-182A	906,00	C		3 doors	>91	MP-w	Fe45	A2BCEX	38	RAC
	ABO-0106-182A	1,536,00	C		3 doors	>91	MP-w	Cr-Mo	A2BCDEKLQ	38	RAC
	ABO-0106-182AW	1,441,00	C		3 doors	>91	MP-w-w	Cr-Mo	A2BCDEKLQ	38	RAC
	ABO-105P-126	786,00	C	205	3 doors	>83<98	10 b	Fe45	A2SX	26	FIA-ALL J
	ABO-0105-126A	876,00	C		3 doors	>83<98	MP-w	Fe45	A2B	27	FIA-ALL J
	ABO-0106-126	1,535,00	C		3 doors	>83<98	MP-b	Cr-Mo	A2BEFGH3SX	26	ONS
	ABO-105P-320	786,00	C	206		>98<06	6 b	Fe45	A2ESX	23,2	FIA-ALL J
	ABO-0105-217AH	950,00	C		3 doors	>98	MP-w	Fe45	A2BNX	36	FIA-ALL J
	ABO-0106-217A	1,812,00	C		3 doors	>98	MP-w	Cr-Mo	A2BCEFGH1H2JLKQ	42	RAC
	ABO-0106-217AW	1,490,00	C		3 doors	>98	MP-w-w	Cr-Mo	A2BCEFGH1H2JLKQ	42	RAC
	ABO-0106-256A	2,154,00	C		RC 3 doors OM. 5667	>98	MP-w	Cr-Mo	A1BCDEFGKLNOR	42	RAC
	ABO-0106-275A	2,683,00	C	207	RC 3 doors OM. A 5724	>07	MP-w	Cr-Mo	A1BCEH2KNRV2X	52	RAC
	ABO-0100-275	1,424,00	C		3 doors	>04/06	6 b	Fe45	A1EH2NRSV2U	45	FIA-ALL J
	ABO-0100-275RS	1,091,00	C		RACING START		6 b	Fe45	A2ENRSV2U	41	FIA-ALL J / RACING START
	ABO-0100-275A	1,436,00	C		3 doors	>04/06	6 w	Fe45	A1CEH2NRSV2U	47	FIA-ALL J
	ABO-0100-337	1,946,00	C	208	3 doors	>12	6 b	Fe45	A1EH3NRSV2U	60	FIA-ALL J
	ABO-0100-337A	2,008,00	C		3 doors	>12	MP-w	Fe45	A1CEH3NRSV2U		FIA-ALL J
	ABO-105P-130	786,00	C	306	3 doors	>94	10 b	Fe45	A2FGSX	28	NO FIA
	ABO-0105-130A	906,00	C		3 doors	>94	MP-w	Fe45	A2BEX	34	RAC
	ABO-0106-130A	1,867,00	C		3 doors	>94	MP-w	Cr-Mo	A1BCEH2JJKLQZ	38	ONS
	ABO-0100-360	1,862,00	C	308		>15	6 B	Fe45	A3H3NRV2U	53	FIA-ALL J
	ABO-105P-128	786,00	C	309	3 doors	>85<93	10 b	Fe45	A2SX	26	FIA-ALL J
	ABO-0105-128A	907,00	C		3 doors	>85<93	MP-w	Fe45	A2BX	29	FIA-ALL J
	ABO-0106-128B	1,642,00	C		3 doors	>85<93	MP-b	Cr-Mo	A2BCEFGILQS	27	ONS
	ABO-0106-128A	990,00	C		3 doors	>85<93	MP-w	Cr-Mo	A2EIL	17	ONS
	ABO-105P-264	931,00	C	504	V6	>71<80	6 b	Fe45	A2SX	30	FIA-ALL J
POLARIS											
	ABO-0100-343	1,874,00	C	RZR	XP 900		8 w	Fe45	A3CH3KNORZ	53	NO FIA
PORSCHE											
	ABO-0100-274	889,00	C	911		>65<73	6 b	Fe45	A2SX	26	FIA-ALL J
	ABO-0100-274K	1,537,00	C			>65<73	6 b	Fe45	A3NRSUV2	46	FIA-ALL J
	ABO-0100-131	868,00	C			>74 < 90	6 b	Fe45	A2SX	26	FIA-ALL J
	ABO-0100-131S	1,376,00	C			>74 < 90	6 b	Fe45	A3NV2US	42	FIA-ALL J
	ABO-0100-131SK	1,544,00	C			>74 < 90	6 b	Fe45	A3NRSUV2	46	FIA-ALL J
	ABO-0100-268	1,914,00	C	911	GT3 RS (997)	>07	10 b	Fe45	A1BCEH1NUV2	50	FIA-ALL J
	ABO-105P-322	830,00	C	944		>82<91	6 b	Fe45	A2SX	20	FIA-ALL J
	ABO-105P-322	830,00	C	968		>82<91	6 b	Fe45	A2SX	20	FIA-ALL J
	ABO-105P-323	870,00	C	996	GT3	>98<04	6 b	Fe45	A2ESX	21,5	FIA-ALL J
	ABO-0100-268	1,914,00	C	997	Carrera 4	>09/07	10 b	Fe45	A1BCEH1NUV2	50	FIA-ALL J
RENAULT											
	ABO-105P-329	965,00	C	ALPINE A 110		>66<72	6 b	Fe45	A2SX	18,7	FIA-ALL J
	ABO-105P-330	965,00	C	ALPINE A 310		>71<84	6 b	Fe45	A2SX	21	FIA-ALL J
	ABO-105P-144	786,00	C	CLIO 1st series	3 doors	>90<98	10 b	Fe45	A2EX	25,7	FIA-ALL J
	ABO-105P-144RS	1,091,00	C		RACING START		6 b	Fe45	A2ENRSV2U	35	FIA-ALL J / RACING START
	ABO-0105-144A	875,00	C		3 doors	>90<98	MP-w	Fe45	A2BDEX	33	FIA-ALL J
	ABO-0106-144A	1,729,00	C		3 doors	>90<98	MP-w	Cr-Mo	A2BCEIJLQ	25	ONS
	ABO-0106-144AW	1,118,00	C		3 doors	>90<98	MP-w-w	Cr-Mo	A2BCEIJLQ	25	ONS
	ABO-0105-144T	871,00	C		Trofeo	>90<98	12 b	Fe45	A2	35	ONS
	ABO-0106-220A	1,669,00	C	CLIO 2nd series	RS 2000 16V	>98<05	MP-w	Cr-Mo	A2BCDEFGH1JJKLQ	35,3	RAC
	ABO-0106-233A	2,010,00	C		RS 2000 16V	>98<05	MP-w	Cr-Mo	A1BCEH2JKLNQR	48	RAC
	ABO-0106-233AW	1,831,00	C		RS 2000 16V	>98<05	MP-w-w	Cr-Mo	A1BCEH2JKLNQR	48	RAC
	ABO-0105-220AH	1,059,00	C		All models	>98<05	MP-w	Fe45	A2BNX	38	FIA-ALL J
	ABO-105P-220H	1,206,00	C		All models	>98<05	10 b	Fe45	A2ENSX	38	FIA-ALL J
	ABO-105P-220HRS	1,091,00	C		RACING START		6b	Fe45	A2ENRSV2U	44	FIA-ALL J / RACING START
	ABO-0100-260A	1,433,00	C	CLIO 3rd series	3 doors all models	>05<12	10 b	Fe45	A2EFGNRSV2U	47	FIA-ALL J
	ABO-0106-260A	2,725,00	C		3 doors RS2000 om N/A 5704	>05<12	MP-W	Cr-Mo	A1BCDEH1KNRV2	57	RAC
	ABO-0100-358	1,573,00	C	CLIO 4th series		>13	6 b	Fe45	A1H1ENRSV2U		FIA-ALL J
	ABO-105P-136	786,00	C	MEGANE 1st series	3 doors	>97<99	10 b	Fe45	A2EX	27	FIA-ALL J
	ABO-0105-136A	907,00	C		3 doors	>97<99	MP-w	Fe45	A2B	33	FIA-ALL J
	ABO-0106-136A	1,910,00	C		2.0 16V Coach 3 doors	>97<99	MP-w	Cr-Mo	A3BCH2H3JQ	40	RAC
	ABO-0100-339	1,520,00	C	MEGANE 3rd series	Saloon 3 doors	>08	6 b	Fe45	A1EH2NRSUV2	51	FIA-ALL J
	ABO-0100-357	1,775,00	C	MEGANE 4th series	Saloon 4 doors	>16	6 b	Fe45	A3EH1NRSV2U		FIA-ALL J

R	Ref	Euro	Car	Version	Year	Fix Point	Mat	Feat.	Kg	Hom	
	AB0-105P-326	867,00	C	R5	Turbo 1-2 (rear engine)	>75<85	6 b	Fe45	A2SX	24,2	FIA-ALL J
	AA0-104P-142	868,00	C	R11	Turbo	>83<89	6 b	Fe45	A2SX		NO FIA
	AB0-105P-328	916,00	C	R12		>69<80	6 b	Fe45	A2SX	23,2	FIA-ALL J
	AB0-105P-138	786,00	C	Super 5	GT Turbo	>84<96	10 b	Fe45	A2ESX	26	FIA-ALL J
	AB0-0105-138A	907,00	C		GT Turbo	>84<96	MP-w	Fe45	A2B	33	FIA-ALL J
	AB0-0106-138A	1,398,00	C		GT Turbo	>84<96	MP-w	Cr-Mo	A2BCEH1JLQ	25	ONS
	AB0-0106-138AW	1,124,00	C		GT Turbo	>84<96	MP-w-w	Cr-Mo	A2BCEH1JLQ	25	ONS
SEAT											
	AB0-0106-45A	1,419,00	C	CORDOBA	3 doors		MP-w	Cr-Mo	A1BCDEH2H3JLQ	38	RAC
	AB0-105P-45	786,00	C	IBIZA 2nd series	3 doors	>93<02	10 b	Fe45	A2SX	25	FIA-ALL J
	AB0-0106-45A	1,419,00	C		3 doors	>93<02	MP-w	Cr-Mo	A1BCDEH2H3JLQ	37	ONS
	AB0-0106-219A	1,419,00	C			>99	MP-w	Cr-Mo	A1BCDEH2H3JLQ	38	RAC
	AB0-0106-228A	1,866,00	C	IBIZA 3rd series	3 doors	>01/02<09	MP-w	Cr-Mo	A1BCDEGH2JLNQ	37	RAC
	AB0-0100-228H	1,204,00	C		3 doors	>01/02<09	6 b	Fe45	A2NV2U	60	FIA-ALL J
	AB0-105P-226	786,00	C	LEON 1st series	5 doors	>03/00	10	Fe45	A2SX	25	NO-FIA
	AB0-0100-255A	1,454,00	C	LEON 2nd series	5 doors	>09/05	MP-w	Fe45	A2ENORX	47	FIA-ALL J
	AB0-0100-255	1,899,00	C		5 doors	>09/05	6 b	Fe45	A1DEJNRSX	39	FIA-ALL J
	AA0-104P-46	868,00	C	MARBELLA			6 b	Fe45	A2SX	31	NO-FIA
SKODA											
	AB0-0100-266	1,643,00	C	FABIA	5 doors	>01/08	10	Fe45.2	A2EGH1NQRSV2U	30	FIA-ALL J
SUBARU											
	AB0-105P-165	786,00	C	IMPREZA	2.0 4WD	>92<00	10 b	Fe45	A2ESX	29	FIA-ALL J
	AB0-0106-231A	2,785,00	C		2.0 4WD 5650, 5651, 5652, 5656, 5676, 5695	>12/00	MP-w	Cr-Mo	A1BCDEH1KNOQ	57	RAC
	AB0-0100-261A	1,515,00	C		WRX STI	>10/07	10 w	Fe45	A1ENRV2U	35	FIA-ALL J
	AB0-0106-261A	2,881,00	C		WRX STI 5714 - 5732	>10/07	Mp-w	Cr-Mo	A1BCEH1KLNORX	58	RAC
	AB0-0106-261AW	2,261,00	C		WRX STI 5714 - 5732	>10/07	Mp-w-w	Cr-Mo	A1BCEH1KLNORX	58	RAC
SUZUKI											
	AB0-105P-200	786,00	C	BALENO		>95	10 b	Fe45	A2EX	27	FIA-ALL J
	AA0-104P-139	868,00	C	SWIFT 1st series	1.3 GTi 16V 3 doors	<89	8 b	Fe45	A2SX	27	NO-FIA
	AB0-105P-180	786,00	C	SWIFT 2nd series	1.3 GTi 16V 3 doors	>90	10 b	Fe45	A2X	27	FIA-ALL J
	AB0-0105-180S	798,00	C		1.3 GTi 16V 3 doors	>90	MP-b	Fe45	A2BX	38	FIA-ALL J
	AB0-0106-251A	2,502,00	C	SWIFT 4th series	1.3 RS A5684	>05/05<10	MP-w	Cr-Mo	A1BCEH2H3KNOR	55	RAC
	AB0-0100-251AH	1,634,00	C		all models	>05/05<10	MP-w	Fe45	A2BOH1V2U	50	FIA-ALL J
TALBOT											
	AA0-104P-147	868,00	C	SAMBA			6 b	Fe45	A2SX	31	FIA-ALL J
	AA0-104P-145	868,00	C	SIMCA	Rally I/ Rally II		6 b	Fe45	A2SX	32	FIA-ALL J
	AA0-104P-146	868,00	C	SUNBEAM	1.6 Ti/ Lotus		6 b	Fe45	A2SX	31	FIA-ALL J
	AB0-0100-347	1,502,00	C		Ti 1.6	>77<81	6 b	Fe45	A3EH2NSV2U	46	FIA-ALL J
TOYOTA											
	AB0-105P-173	786,00	C	CELICA	(T18) GT / T20	<99	10 b	Fe45	A2X	29	FIA-ALL J
	AB0-0100-250A	1,313,00	C	YARIS 1st series	3 doors	>99<05	MP-w	Fe45	A1ENO	40	FIA-ALL J
	AB0-0100-250	1,424,00	C		3 doors	>99<05	MP-b	Fe45	A1ENO	40	FIA-ALL J
	AB0-0100-341	1,399,00	C	YARIS 3rd series	3 doors	>10/11<13	6 b	Fe45	A1EH3NRSV2U	48	FIA-ALL J
VOLKSWAGEN											
	AA0-104P-152	868,00	C	GOLF 1st series		<80	6 b	Fe45	A2SX	32	FIA-ALL J
	AA0-104P-153	868,00	C			>80<83	6 b	Fe45	A2ESX	30	FIA-ALL J
	AA0-104P-154	868,00	C	GOLF 2nd series		>84	6 b	Fe45	A2SX	30	NO FIA
	AA0-104P-154	868,00	C		Rally	<91	6 b	Fe45	A2SX	30	NO FIA
	AB0-0106-154B	1,929,00	C			>84<91	MP-b	Cr-Mo	A2BCDEFGH1IQ	32	ONS
	AB0-0106-154A	1,729,00	C			>84<91	MP-w	Cr-Mo	A2BCDEFGH1IQ	30	ONS
	AB0-105P-156	786,00	C	GOLF 3rd series	3 doors	>91<98	10 b	Fe45	A2SX	30	NO FIA
	AB0-0106-156A	1,947,00	C		3 doors	>91<98	MP-w	Cr-Mo	A3BCDEH1JLQ	38	ONS
	AB0-0105-202SH	1,388,00	C	GOLF 4th series	5 doors	>98	MP-b	Fe45	A2BNOX	48	FIA-ALL J
	AB0-105P-202H	1,232,00	C		5 doors	>98	10 b	Fe45	A2NV2U	37	FIA-ALL J
	AB0-105P-215	786,00	C	LUPO		>98<05	6 b	Fe45	A2X	27	FIA-ALL J
	AB0-105P-332	830,00	C	MAGGIOLONE		>51	6 b	Fe45	A2SX	23	FIA-ALL J
	AA0-104P-155	868,00	C	POLO 2nd series		>80<94	6 b	Fe45	A2TX	30	ONS
	AB0-0105-208S	1,124,00	C	POLO 3rd series	3 doors	>94	6 b	Fe45	A1H2H3QS	40	RAC
	AB0-0106-208A	1,505,00	C		3 doors	>94	MP-w	Cr-Mo	A1BCDEH2H3LQ	35	RAC
	AB0-0106-157A	2,120,00	C	POLO 4th series	3 doors	>10/01	MP-w	Cr-Mo	A1BCDEGH1KLNQR	50	RAC
	AB0-0106-232A	2,120,00	C		5 doors	>10/01	MP-w	Cr-Mo	A1BCDEGH1KLNQR	50	RAC
	AB0-0100-348	1,726,00	C	POLO 5th series	3 doors	>09	6 b	Fe45	A1EH2NORSX	50	FIA-ALL J
	AB0-0100-359	2,328,00	C	POLO 6th series		>17	6 b	Fe45	A1EH3KNOQRS	42	FIA-ALL J
	AA0-104P-151	868,00	C	SCIROCCO	old model	<79	6 b	Fe45	A2TX	30	ONS
	AB0-0100-271	1,838,00	C	SCIROCCO 3rd series		>08	6 b	Fe45	A2BDEHNRSV2U	57	FIA-ALL J
	AB0-0100-271A	1,750,00	C			>08	MP-w	Fe45	A1BCDEH1KNRV2U	60	FIA-ALL J

ROLL CAGES CHARACTERISTICS AND TYPOLOGIES

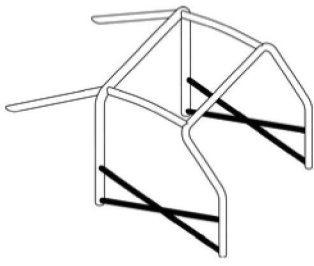

A1
Cross door reinforcements
dwg. 253-9

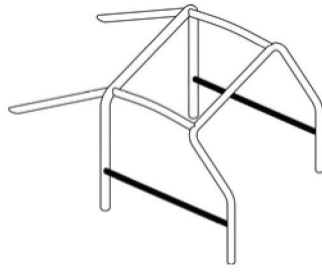

A2
Single door reinforcements
dwg. 253-8

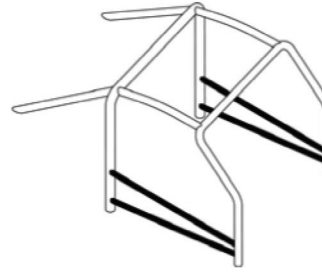

A3
Double door reinforcements
dwg. 253-11

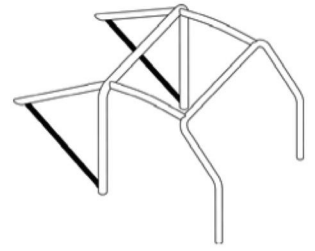

B
Extended door bars
dwg. 253-17

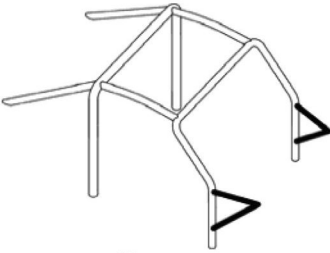

C
Front turret attachment
dwg. 253-25

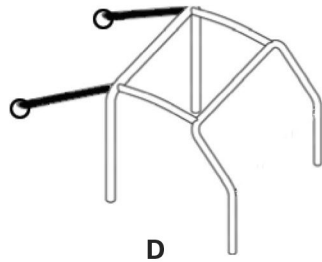

D
Rear turret attachment

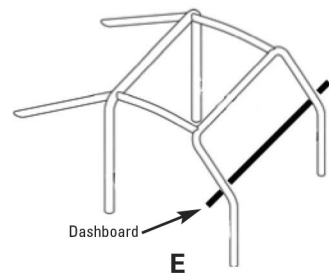

E
Dashboard
Penetrates dashboard

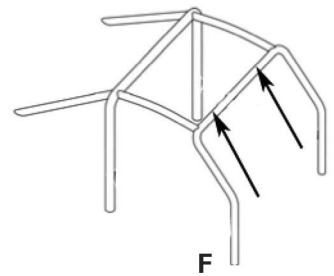

F
Roof attachment (front)

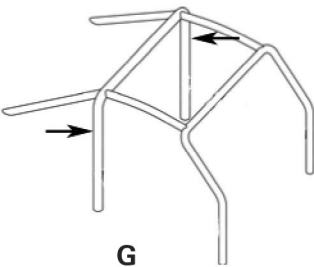

G
Rear attachment points at B pillar

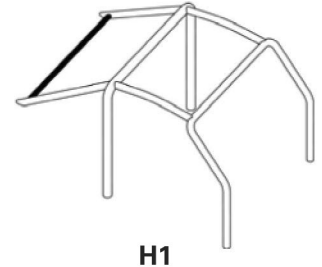

H1
Wrap around harness attachment bar
dwg. 253-18

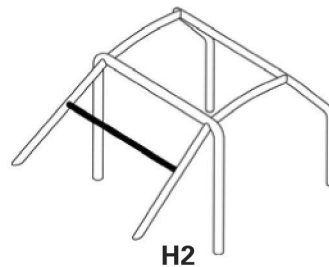

H2
Wrap around harness attachment bar
dwg. 253-28

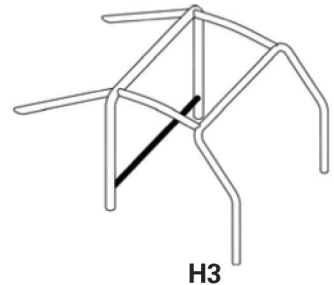

H3
Wrap around harness attachment bar
dwg. 253-30

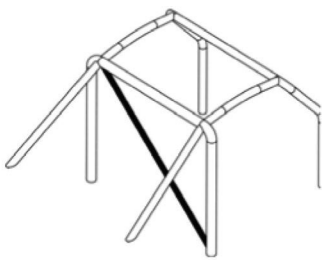

I
Diagonal on main hoop
dwg. 253-5

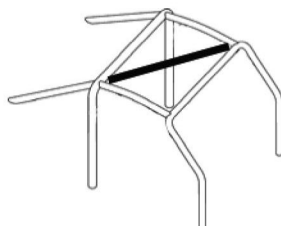

J
Roof diagonal

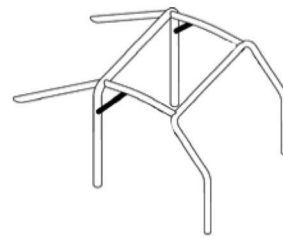

K
Rear hoop reinforcements
dwg. 253-31

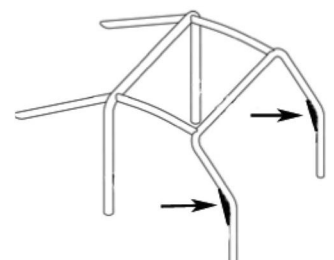

L
Reinforcement gussets on front hoop

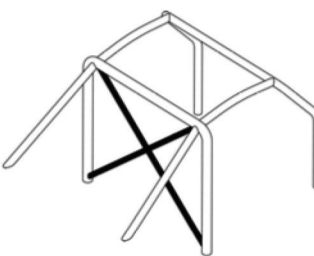

N
X brace on main hoop
dwg. 253-7

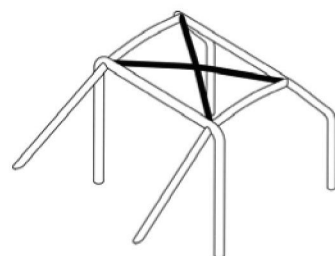

O
X brace on roof
dwg. 253-12

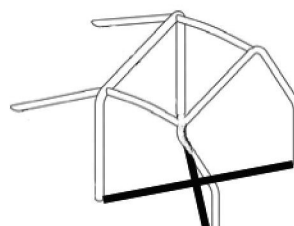

P
X brace on floor
dwg. 253-31

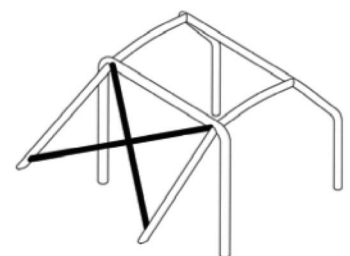

Q
X brace on back stays
dwg. 253-21

NOTE: **valid for the tables showing the model of the car:** for all the vehicles models where it isn't expressly indicated the year of the production-end: it's intended that the application is valid until the discontinued-product date.

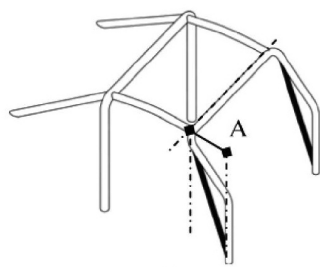

R

Reinforcement between main hoop and floor attachment point of front hoop
dwg. 253-15

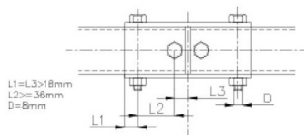

S

Sleeve connecting tubes
dwg. 253-41

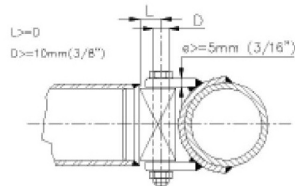

T

Fork/gudgeon pin connection between front and rear hoop
dwg. 253-40

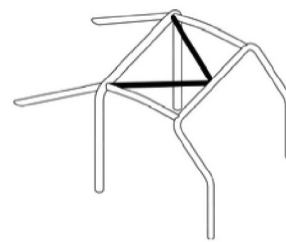

V1

V on roof

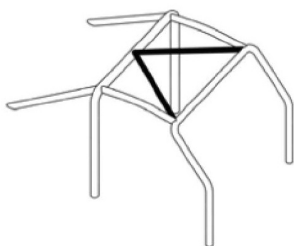

V2

V on roof

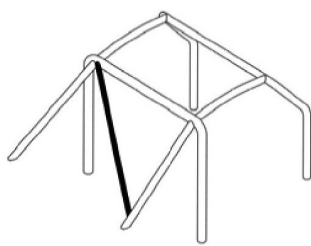

X

X diagonal on rear arm
dwg. 253-20

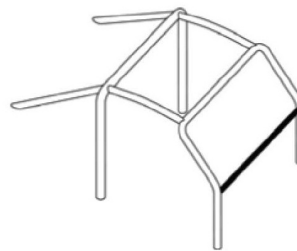

Z

Dashboard crossbar
dwg. 253-29

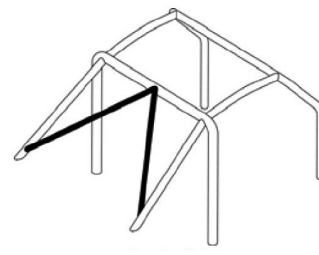

U

U on rear arm
dwg. 253-22

Fixing point typology:

b = bolt in;

w = weld in;

MP-b = multipoints bolt-in;

MP-w = multipoints weld-in;

MP-w-w = not ass.

Omologazioni:

- FIA-ALL J Complies with FIA norms: Appendix "J" Art. 253
- ONS Homologated by ONS ASN
- RAC Homologated by RAC ASN

Attention:

- All roll cages are made for models without a sunroof except where indicated.
- **All the rollcages model type 100 - 105 - 105P, that are complying to the FIA Appendix J, can also be requested in the RACING START configuration**

**Remarks only for rollbar AB/105P/225:

- After mounting the rollcage you can not reinstall the original hardtop.

***Remarks right for roll cages AB/105/218ASH and AB/105/218AH:

- The AS version has cross door bars ("X") and the reinforcements continues down to the floor joining the rear section.
- The A version has a simple door bar, but still the reinforcement continues down to the floor joining the rear section.
- The AS version has cross between the rear brace, while A version has just a diagonal tube.
- The AS version has a little transverse reinforcement tube between the main hoop and lateral hoop, while A version doesn't have it.
- Main hoop is identical in both version and both cages go through the dashboard.

Please visit www.ompracing.com
to view the 3D render of the complete configuration of your roll bar.

OFF ROAD ROLL CAGES

Application List

R	Ref	Euro	Car	Version	Year	Mat	Feat.	Fix Point	Hom
SUZUKI									
	ARO-0204	802,00	C	JIMNY	1.3		Fe45	6 b	NO FIA
	ARO-0101	847,00	C	SJ410-SJ413 SAMURAI			Fe45	6 b	NO FIA
	ARO-0100	372,00	C	SJ410-SJ413 SAMURAI only rear roll bar without cross member			Fe45	6 b	NO FIA
	ARO-0901	901,00	C	VITARA			Fe45	6 b	NO FIA
TOYOTA									
	ARO-0701	902,00	C	BJ71			Fe45	6 b	NO FIA

All OFF-ROAD cages are suitable for soft top cars with short wheel base and are also suitable for road use. They are made from diam. 50x2 mm or diam. 40x2 mm tube.

ROLLBARS ACCESSORIES

Descriptive List

R	Ref	Euro	Description	Colour	FIA
ROLL CAGE ACCESSORIES					
	AA0-0111-A01	279,00	C Assembled (welded) pair cross door reinforcement, 1.25 mt long, diameter 40x2; gasses, reinforcements and connections included.		
	AA0-0111-C01	277,00	C Assembled (welded) pair cross door reinforcement, 1.25 mt long, diameter 40x2; Connecting sleeves included. FIA rules.		FIA-ALL J
	AA0-0111-B01	229,00	C Not assembled (to be welded) pair cross door reinforcement, 1.25 mt long, diameter 40x2; gasses, reinforcements and connections included.		
	AA0-0202	145,00	C Universal harness fixing bar to be welded TO the chassis. Supplied raw, WITH nuts and bolts included. Adaptable on the chassis.		FIA-ALL J
	AA0-0175-B01	136,00	C Kit reinforcement plate for special roll bars AB/106/,,, and AB/105/A.		
	AA0-0110-B01	130,00	C Roll bar ONS homologation certificate German federation DMSB.		
	AA0-0204	124,00	C Pair of door reinforcements (1.25 mt long) in FE45, diameter 40x2 mm. Supplied with connecting sleeves. To be welded TO following rollbars AA/104, AB/105, AB/100 - nuts and bolts included		FIA-ALL J
	AA0-0109	120,00	C Pair of door bars (1.25 mt. Length) Ø 40x2 mt FE 45 steel, to be welded. To AA/104, AB/105 and AB/100, complete with connections.		
	AA0-0110-A01	85,00	C Roll bar RAC homologation certificate British federation MSA.		
	AA0-0108	78,00	C Pair of door bars (1.20 mt. Length) Ø 40x2 mt FE 45 steel, to be welded.		
	AA0-0113-A01	58,00	C Pair of door bar covers in velvet type material (same as our competition seats) to cover rubber sleeving Ref. AA/113. 100 cm long. Velcro closing.	Black (AA0-0113-A01)	
	AA0-0113-B01	38,00	C Pair of door bar covers in velvet type material (same as our competition seats) to cover rubber sleeving Ref. AA/113. 50 cm long. Velcro closing.	Black (AA0-0113-B01)	
	AA0-0113-D01	36,00	C Foamed rubber sleeving for roll bar with tube diameter 50mm. Sold in pieces of 2m.	Black (AA0-0113-D01)	
	AA0-0113-C01	26,00	C Foamed rubber sleeving for roll bar with tube diameter 40 mm. Sold in pieces of 2m.	Black (AA0-0113-C01)	
	AA0-0203	26,00	C Kit (2+2) of perforated plates for rollbar fixing in.		FIA-ALL J
	AA0-0115	25,00	C Molded energy absorbing roll bar padding suitable for both 40mm and 50mm inner diameters. Length: 490mm.	Black (AA0-0115)	FIA 8875-2001 type A
	AA0-0116	25,00	C Molded energy absorbing roll bar padding suitable for both 30mm and 40mm inner diameters. Length: 490mm.	Black (AA0-0116)	FIA 8875-2001 type A
	AA0-0195	19,00	C Sleeve connecting tube in FE45 steel for 40 mm tubing.		FIA-ALL J
	AA0-0200	16,00	C 80° gusset to reinforce rollbar crosses of diameter 40mm. Thickness: 1,5mm.		FIA-ALL J
	AA0-0201	16,00	C 100° gusset to reinforce rollbar crosses of diameter 40mm. Thickness: 1,5mm.		FIA-ALL J
	AA0-0175-A01	12,70	C Universal "L" shaped reinforcement plate. Adjustable and suitable for any standard steel roll-bar. 3mm thick.		FIA-ALL J
	AA0-0123	10,30	C Reinforcement to be used with connections AA/122 and AA/122-50.		
	AA0-0122-A01	9,90	C Connection for roll bar with tube diameter 40mm, complete with hardware.		
	AA0-0122-B01	9,50	C Connection for roll bar with tube diameter 50mm, complete with hardware.		
	AA0-0175-C01	6,00	C Flat plate 100x120x3 mmlower reinforcement for standard roll bars.		FIA-ALL J

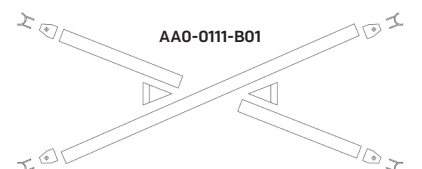
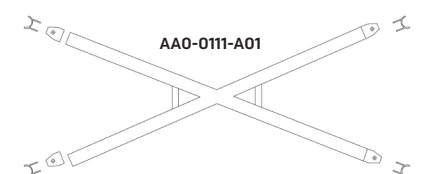
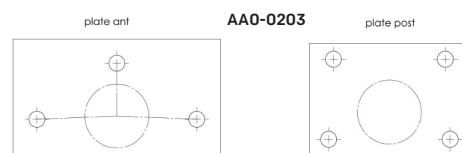
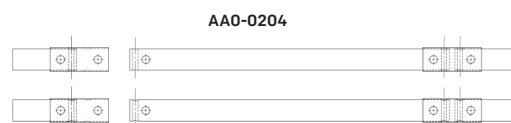
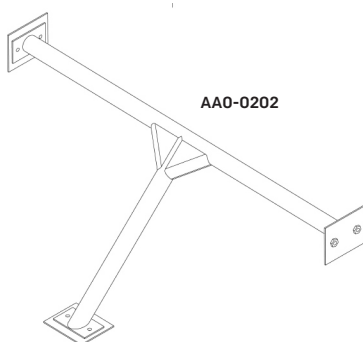

EXTINGUISHERS & SYSTEMS

Descriptive List

R	Ref	Euro	Description	Colour	Homologation	Weight
EXTINGUISHING SYSTEMS FOR SALOON, SPORT AND SINGLE SEATER CARS						
ONE COLLECTION						
N	CE0-FAL4-A01		<p>C CEFAL4: This fire extinguisher system is homologated FIA 8876-2022, the last and innovative FIA standard for plumbed in-fire suppression system for open cockpit cars. The bottle is made in aluminum with an innovative save spacing solution. The system covers a wide range of fuels (from petrol till E85 CLASS I II and V (E85)) and it is suitable for electric and hybrid cars also. The extinguishing medium when released, is non-corrosive and not electrically conductive. In contrast to foam or powder, it does not leave any damaging residues, so the systems do not have to be cleaned and remain up and running after the release of the fluid. The system gets pressurized when activated, enabling the discharge of the extinguishant. The electrical system is waterproof and ready to be installed and the ECU is IP65 and IP67 certified. Fixing brackets, clamps, piping, and connections are included. Bottle weight: 3,2 Kg. Diameter: 110 mm. Length: 275 mm.</p> <p>Homologated for fuels below: Petrol Petrol + up to 30% ethanol or methanol (E30) Petrol + up to 85% ethanol or methanol (E85)</p>	Silver/yellow (CE0-FAL4-A01)	FIA 8876-2022	3,2 Kg
	CE0-SAL4-A01	2.550,00	<p>C CESAL4 L: Very compact and ultralight fire extinguisher system, electrically activated, suitable for saloon cars. FIA 8865-2015 rules complying. Aluminium bottle, the extinguisher can turn off fire in few seconds injecting in the cockpit and in the engine bay different fire-extinguishing medium. The system gets pressurized when activated enabling the discharge of the extinguishant. 3 noozles are for the engine bay in order to protect the most critical and dangerous parts depending on the type of vehicle, 2 noozles are for the cockpit to ensure the driver front and rear protection. Fixing brackets, clamps, tubing and connections are included. Bottle weight: 5,4 Kg. Diameter: 130 mm. Length: 274 mm.</p> <p>Homologated for fuels below: petrol petrol + max 30% ethanol (methanol) petrol + max 85% ethanol (methanol) E85</p> <p>"L" version, suitable for medium-large sized cockpit (from 3.73 m3 to 1.99 m3).</p>	Black/yellow (CE0-SAL4-A01)	FIA 8865-2015	5,4 Kg
	CE0-SAL4-B01	2.550,00	<p>C CESAL4 S: Very compact and ultralight fire extinguisher system, electrically activated, suitable for saloon cars. FIA 8865-2015 rules complying. Aluminium bottle, the extinguisher can turn off fire in few seconds injecting in the cockpit and in the engine bay different fire-extinguishing medium. The system gets pressurized when activated enabling the discharge of the extinguishant. 3 noozles are for the engine bay in order to protect the most critical and dangerous parts depending on the type of vehicle, 2 noozles are for the cockpit to ensure the driver front and rear protection. Fixing brackets, clamps, tubing and connections are included. Bottle weight: 5,4 Kg. Diameter: 130 mm. Length: 274 mm. Homologation: 8865-2015</p> <p>Homologated for fuels below: petrol petrol + max 30% ethanol (methanol) petrol + max 85% ethanol (methanol) E85</p> <p>"S" version, suitable for small sized cockpit (from 2.2 m3 to 1.2 m3).</p>	Black/yellow (CE0-SAL4-B01)	FIA 8865-2015	5,4 Kg
	CE0-SAL4-C01	2.550,00	<p>C CESAL4 XS: Ultra compact lightweight fire extinguisher system, electrically activated, suitable for saloon cars. FIA 8865-2015 rules complying. Aluminium bottle, two different fire-extinguishing medium for cockpit and engine bay. Fixing brackets, clamps, tubing and connections are included. Bottle weight: 5,4 Kg. Diameter: 115 mm. Length: 258 mm. Homologation: FIA 8865-2015</p> <p>Homologated for fuels below: petrol petrol + up to 30% ethanol or methanol petrol + up to 85% ethanol or methanol E85</p> <p>"XS" version suitable for ultra small sized cockpit (from 0,6m3 to 1,12m3)</p>	Black/yellow (CE0-SAL4-C01)	FIA 8865-2015	5,4 Kg
TECNICA COLLECTION						

R	Ref	Euro		Description	Colour	Homologation	Weight
	CE0-SAL5-C01	1.665,00	C	CESAL5 SE: Full Novec1230® extinguishing system electrically activated, suitable for both electric and petrol cars. Two nozzles for cockpit, two nozzles for engine bay, one nozzle for extra position / inverters (not use into the cockpit). New control unit with dedicated low-battery alarm. Diameter: 160mm. Bottle weight: 6,5 Kg. Length: 309mm. Homologation: FIA 8856-2015 Homologated for fuels below: petrol suitable for hybrid/electric cars "S version suitable for small sized cockpit (from 1.35 m3 to 2.5 m3).	Silver (CE0-SAL5-C01)	FIA 8865-2015	6,5 Kg
	CE0-SAL5-D01	1.665,00	C	CESAL5 LE: Full Novec1230® extinguishing system electrically activated, suitable for both electric and petrol cars. Two nozzles for cockpit, two nozzles for engine bay, one nozzle for extra position / inverters (not use into the cockpit). New control unit with dedicated low-battery alarm. Diameter 160mm. Bottle weight: 6,5 kg. Length: 350 mm. Homologation: FIA 8856-2015 Homologated for fuels below: petrol suitable for hybrid/electric cars "L" version suitable for medium-large sized cockpit (2.2 up to 4.1 m3).	Silver (CE0-SAL5-D01)	FIA 8865-2015	6,5 Kg
	CE0-SAL5-A01	1.550,00	C	CESAL5 L: Entry level fire extinguishing system electrically activated. Aluminium bottle, the extinguisher can extinguish fire in few seconds injecting in the cockpit and in the engine bay different fire-extinguishing medium. Fixing brackets, clamps, tubing and connections included. Diameter 160mm. Bottle weight: 6 kg. Length: 350 mm. Homologation: FIA 8856-2015 Homologated for fuels below: petrol diesel petrol + up to 30% ethanol or methanol (E30) petrol + up to 85% ethanol or methanol (E85). "L" version suitable for medium-large sized cockpit (2.2 up to 4.1 m3).	Silver (CE0-SAL5-A01)	FIA 8865-2015	6 Kg
	CE0-SAL5-B01	1.550,00	C	CESAL5 S: Entry level fire extinguishing system electrically activated. Aluminium bottle, the extinguisher can extinguish fire in few seconds injecting in the cockpit and in the engine bay different fire-extinguishing medium. Fixing brackets, clamps, tubing and connections included. Diameter: 160mm. Bottle weight: 6 Kg. Length: 309mm. Homologation: FIA 8856-2015 Homologated for fuels below: petrol diesel petrol + up to 30% ethanol or methanol (E30) petrol + up to 85% ethanol or methanol (E85). "S version suitable for small sized cockpit (from 1.35 m3 to 2.5 m3).	Silver (CE0-SAL5-B01)	FIA 8865-2015	6 Kg
N	CE0-SAL5-E01	3.300,00	C	CESAL 5 Double Bottle: In some categories, two FIA 8865 2015 fire extinguisher system are required (i.e. T1, T5 etc). CE0-SAL5-E01 is a double system suitable where 2 system are needed or for volume between 4.4 and 8.2 m3. For any request, including retrofit of single-bottle systems, contact Racing Force or an authorized dealer.	Silver (CE0-SAL5-E01)	FIA 8865-2015	12 Kg
PLATINUM COLLECTION							
	CE0-SAL3-A01	769,00	C	CESAL3: Extinguishing sytem (engine compartment and cockpit) for saloon cars, electrically activated, with control box, tubing, noozles. New ultrlight aluminium bottle with reduced dimensions.1,3 lt Ecolife. Complete with stainless steel brackets and fixing clamps.Diameter 130 mm. Length 204 mm.	Silver (CE0-SAL3-A01)	FIA 2000/ECOLIFE GOLD SALOON N° EX.035.11	2,5 Kg
	CE0-SAL3-B01	699,00	C	CESAL3R: Extinguishing sytem (engine compartment and cockpit) for saloon cars, electrically activated, with control box, tubing, noozles. Aluminium bottle with reduced dimensions. 2.8 lt Ecolife. Complete with stainless steel brackets and fixing clamps. Diameter 160 mm. Length 245 mm. Special for rally cars.	Silver (CE0-SAL3-B01)	FIA 2000	4,3 Kg
	CE0-FAL3-A01	684,00	C	CEFAL3: Extinguishing sytem (engine compartment and cockpit) for formula cars, electrically activated, with control box, tubing, noozles. New ultrlight aluminium bottle with reduced dimensions.0,9 lt Ecolife. Complete with stainless steel brackets and fixing clamps.Diameter 100 mm. Length 194 mm.	Silver (CE0-FAL3-A01)	FIA 2000/ECOLIFE GOLD ONE SEAT N°EX.036.11	1,8 Kg
WHITE COLLECTION							
	CE0-SAL2-A01	629,00	C	CESAL2: Extinguishing sytem (engine compartment and cockpit) for saloon cars, electrically activated, with control box, tubing, noozles, aluminium bottle.4,25 lt Ecolife. Complete with stainless steel brackets and fixing clamps. Diameter 160 mm. Length 315 mm.	White (CE0-SAL2-A01)	FIA 2000	6,2 Kg
	CE0-FAL2-A01	564,00	C	CEFAL2: Extinguishing sytem (engine compartment and cockpit) for formula cars, electrically activated, with control box, tubing, noozles, aluminium bottle. 2.8 lt Ecolife. Complete with stainless steel brackets and fixing clamps. Diameter 160 mm. Length 245 mm.	White (CE0-FAL2-A01)	FIA 2000	4,3 Kg
BLACK COLLECTION							

R	Ref	Euro	Description	Colour	Homologation	Weight
	CE0-SST1-A01	525,00	C CESST1: Extinguishing system (engine compartment and cockpit) for saloon cars, electrically activated, with control box, tubing, nozzles, steel bottle, 4.25 lt Ecolife. Complete with stainless steel brackets and fixing clamps. Diameter 160 mm. Length 330 mm.	Black (CE0-SST1-A01)	FIA 2000	7,7 Kg
	CM0-SST1-A01	299,00	C CMSST1: Extinguishing system (engine compartment and cockpit) for saloon cars, mechanically activated, with tubing, nozzles, steel bottle, 4.25 lt Ecolife. Complete with stainless steel brackets and fixing clamps. Diameter 160 mm. Length 330 mm.	Black (CM0-SST1-A01-071) Red (CM0-SST1-A01-061)	FIA 2000	8,1 Kg
	CM0-FST1-A01	285,00	C CMFST1: Extinguishing system (engine compartment and cockpit) for formula cars, mechanically activated, with tubing, nozzles, steel bottle, 2.8lt Ecolife. Complete with stainless steel brackets and fixing clamps. Diameter 130 mm. Length 330 mm.	Black (CM0-FST1-A01)	FIA 2000	5,6 Kg
OMP SPORT						
	CA0-0372-A01	245,00	C OMP Sport: OMP Sport mechanical extinguishing system in steel. Same features as CMSST: extinguishing system for saloon cars, mechanically activated complete with tubing, nozzles and steel bottle, 4.25 lt Ecolife. Complete with stainless steel brackets and fixing clamps. Diameter 160 mm. Length 330 mm	Red (CA0-0372-A01)	FIA 2000	8,1 Kg
HAND HELD EXTINGUISHERS						
	CB0-0323-A01	339,00	C CAB/323: Hand held fire extinguisher complete with brackets and quick release clamps. STAINLESS STEEL bottle. Extinguishing medium: 2 Kg of 3MTM NovecTM 1230. In compliance with FIA App. J art. 253. Compare to AFFF fire extinguisher system this NOVEC bottle is smaller and lighter. Bottle diameter: 110mm. Bottle weight: 3.150 Kg. Length 360mm.	Silver (CB0-0323-A01)	FIA	3,5 Kg
	CB0-0351-A01	215,00	C CBB/351: Aluminium hand held extinguishers, complete with stainless steel brackets, quick release clamps. Extinguishing liquid: 2.4 lt Ecolife.	White (CB0-0351-A01-020) Red (CB0-0351-A01-061) Silver (CB0-0351-A01-003)	FIA	4 Kg
	CB0-0319-A01	119,00	C CAB/319: Steel hand held extinguishers, complete with aluminium brackets and stainless steel quick release clamps. Extinguishing liquid: 2.4 lt Ecolife.	Black (CB0-0319-A01-071) Red (CB0-0319-A01-061)	FIA	5 Kg
	CB0-0322-A01	99,00	C CAB/322: Steel hand held extinguisher, A/B/C classes complete with aluminium brackets and stainless steel quick release clamps. 4 Kg powder.	Red (CB0-0322-A01)	EN3	6,00 Kg
	CB0-0316-A01	79,00	C CAB/316: Aluminium hand held extinguishers, complete with stainless steel brackets and quick release clamps. 2 kg powder.	Red (CB0-0316-A01)	EN3	3,1 Kg
REPLACEMENT BOTTLES FOR EXTINGUISHING SYSTEMS						
	CE0-SAL4-AB1	2.527,00	C Bottle for extinguishing system CESAL4L	Black/yellow (CE0-SAL4-AB1)	FIA 8865-2015	
	CE0-SAL4-BB2	2.399,00	C Bottle for extinguishing system CESAL4S	Black/yellow (CE0-SAL4-BB2)	FIA 8865-2015	
	CE0-SAL4-CB1	2.399,00	C Bottle for extinguishing system CESAL4XS	Black/yellow (CE0-SAL4-CB1)	FIA 8865-2015	
	CE0-SAL5-CB1	1.530,00	C Bottle for extinguishing system CESAL5SE	Black/yellow (CE0-SAL5-CB1)	FIA 8865-2015	
	CE0-SAL5-DB1	1.480,00	C Bottle for extinguishing system CESAL5LE	Black/yellow (CE0-SAL5-DB1)	FIA 8865-2015	
	CE0-SAL5-AB1	1.474,00	C Bottle for extinguishing system CESAL5L	Silver (CE0-SAL5-AB1)	FIA 8865-2015	
	CE0-SAL5-BB1	1.388,00	C Bottle for extinguishing system CESAL5S	Silver (CE0-SAL5-BB1)	FIA 8865-2015	
	CE0-SAL3-AB1	707,00	C Aluminium bottle for extinguishing system CESAL3	Silver (CE0-SAL3-AB1)	FIA 2000	
	CE0-SAL3-BB1	636,00	C Aluminium bottle for extinguishing system CESAL3R	Silver (CE0-SAL3-BB1)	FIA 2000	
	CE0-FAL3-AB1	635,00	C Aluminium bottle for extinguishing system CEFAL3	Silver (CE0-FAL3-AB1)	FIA 2000	
	CE0-SAL2-AB1	593,00	C Aluminium bottle for extinguishing system CESAL2	White (CE0-SAL2-AB1)	FIA 2000	
	CE0-FAL2-AB1	530,00	C Aluminium bottle for extinguishing system CEFAL2	White (CE0-FAL2-AB1)	FIA 2000	
	CE0-SST1-AB1	490,00	C Steel bottle for extinguishing system CESST1	Black (CE0-SST1-AB1)	FIA 2000	
	CM0-SST1-AB1	256,00	C Steel bottle for extinguishing system CMSST1.	Black (CM0-SST1-AB1-071) Red (CM0-SST1-AB1-061)	FIA 2000	
	CM0-FST1-AB1	246,00	C Steel bottle for extinguishing system CMFST1	Black (CM0-FST1-AB1)	FIA 2000	
	CA0-0372-AB1	184,00	C Steel bottle for extinguishing system CA/372.	Red (CA0-0372-AB1)	FIA 2000	

EXTINGUISHERS ACCESSORIES

Descriptive List

R	Ref	Euro	Description
STEEL AND ALUMINIUM EXTINGUISHER BRACKETS			
	CD0-0408	64,00	C Fixing kit for 130 diameter extinguishing systems (CESAL4, CMFST1). Two-pieces bracket with anti-torpedo and clamps with screw fixing. Quick to mount, other anti torpedo tabs are not required.
	CD0-0417	49,50	C Fixing kit for 160 diameter extinguishing systems (CESAL5, CESAL3R, CEFAL2, CESAL2, CMSST1, CESST1). Two-pieces bracket with anti-torpedo and clamps with screw fixing. Quick to mount, other anti torpedo tabs are not required.
	CD0-0418	49,50	C Inox steel fixing bracket and clamps for CAB/323 hand held extinguisher.
	CD0-0400-B01	30,00	C Fixing kit for CEFAL3 extinguishing systems. Single bracket with anti-torpedo and clamps with screw fixing. Quick to mount, other anti torpedo tabs are not required.
	CD0-0401-B01	30,00	C Fixing kit for CESAL3 extinguishing systems. Single bracket with anti-torpedo and clamps with screw fixing. Quick to mount, other anti torpedo tabs are not required.
	CD0-0405	29,50	C Fixing kit for CAB/322 hand held extinguisher. Two-pieces bracket and clamps with quick release. Quick to mount, needs anti-torpedo tabs CD/311/S-AT.
	CD0-0312	26,50	C Bracket for hand held STEEL extinguishers Ecolife: CAB/319, 132 mm diameter, consisting of 2 aluminium cast bases and 2 quick release stainless steel clips.
	CD0-0356	25,50	C Bracket for ALUMINIUM HAND HELD extinguisher: CBB/351, 130 mmm diameter, consisting of 2 fused aluminium cast bases and 2 quick release stainless steel clamps.
	CD0-0309	25,00	C Bracket for hand held steel extinguishers Ecolife: CAB/319, 132 mm diameter, consisting of 2 aluminium cast bases and 2 quick release stainless steel clips.
EXTINGUISHER SYSTEM REPLACEMENT PARTS			
	CD0-0360	256,00	C Control box for electrically activated extinguishing systems. With new advanced electronic unit complying with FIA 8856-2015 rules. In "ON" position the red led lamps to indicate the correct system wiring, in "TEST" position the orange led lamps to indicate possible troubles (for example a low battery level). Complying with IP55 waterproof standard.
	CD0-0398	120,00	C Control box for electrically activated units with wiring harness 1.5m.
	CD0-0323-B02	60,00	C Aluminium tubing diameter 8 mm . Long 5 m.
	XMC-CAB-360E	52,00	C CESAL4 electric wiring
	CD0-0323-B01	49,50	C Aluminium tubing diameter 6 mm . Long 3 m.
	XMC-363-E-CAV	29,50	C Electric extinguisher valve cable w.jack. 2017 wiring.
	CD0-0409	26,00	C Fixing bracket for CD/410 nozzle.
	CD0-0335	23,00	C Pull cable for mechanically operated systems.3,2 mt length.
	CD0-0404	22,50	C Bracket for CA/372.
	CD0-0311-A01	17,50	C Spare anti-torpedo brackets for CA/372, CMSST1, CMFST1, CESST1, CESAL2, CEFAL2, CESAL3R extinguishing systems.
	EA0-0467	16,50	C Push-button switches for exterior use, water resistant, with threaded fixing nut. 2 poles.
	CD0-0324-A03	16,00	C Fire resistant sheath, 8 mm diameter, 5 mt roll, to protect electric wire, petrol pipe etc.
	XMC-398-CAV	16,00	C Control box cable.
	CD0-0300-A01	16,00	C Spare anti-torpedo brackets for CESAL3 and CEFAL3 extinguishing systems.
	CD0-0324-A02	16,00	C Fire resistant sheath, 6 mm diameter, 5 mt roll, to protect electric wire, petrol pipe etc.
	CD0-0324-A01	15,00	C Fire resistant sheath, 10 mm diameter, 5 mt roll, to protect electric wire, petrol pipe etc.
	CD0-0390-A01	10,30	C Connection, 3 way with quick couplings for aluminium tubing 6x8 mm.
	CD0-0390-B01	10,30	C 3 way connection with quick attachments, diameter 8 mm.
	CD0-0392-A02	10,30	C 1/8" connection "T" shaped with quick couplings, diameter 8 mm.
	CD0-0407	10,20	C Connection "Y" shaped with quick couplings, diameter 8mm.
	CD0-0323-A01	9,30	C Aluminium tubing diameter 6 mm - 4m.
	CD0-0391-A01	9,30	C 90° end connection, 1/8" shaped with quick couplings for aluminium tubing 6x8mm.
	CD0-0393-A01	9,30	C Atomiser nozzle specifically for Ecolife systems to be threaded onto "T" or "L" connectors.
	CD0-0391-A02	9,30	C 90° end connection , 1/8" shaped with quick attachment, diameter 8 mm.
	CD0-0392-A01	7,80	C Connection "T" shaped with quick couplings for aluminium tubing 6x8mm.
	CD0-0392-A03	7,60	C 1/8" connection "T" shaped with quick couplings, diameter 6 mm.
	CD0-0394	6,70	C Straight connection (1/4" junction) for a 6x8mm aluminium pipe.
	CD0-0395-A01	6,70	C Straight connection (1/8" junction) for a 6x8mm aluminium pipe.
	CD0-0399	6,70	C Reduction tube diameter 6-8 mm.
	XMC-181493	6,20	C Protection for external button red pvc (EA/467) .
	CD0-0391-A03	6,20	C 90° end connection , 1/8" shaped with quick attachment, diameter 6 mm.
	CD0-0395-A02	6,00	C Straight connection (1/8" junction), diameter 8 mm.
SYSTEM SERVICING			
CESAL4 L			
	CR0-6000	1.260,00	C Service for CESAL4L extinguishing system. Activated bottle.
	CR0-6001	642,00	C Service for CESAL4L extinguishing system. No activated bottle.
CESAL4 S			
	CR0-5000	1.131,00	C Service for CESAL4S extinguishing system. Activated bottle.
	CR0-5001	642,00	C Service for CESAL4S extinguishing system. No activated bottle.
CESAL5 L			
	CR0-8000	645,00	C Service for CESAL5L extinguishing system. Activated bottle.
	CR0-8001	305,00	C Service for CESAL5L extinguishing system. Not activated bottle.
CESAL5 S			
	CR0-7000	600,00	C Service for CESAL5S extinguishing system. Activated bottle.
	CR0-7001	305,00	C Service for CESAL5S extinguishing system. Not activated bottle.

R	Ref	Euro	Description
CESAL5 SE			
	CR0-7002	668.00	C Service for CESAL5SE extinguishing system. Activated bottle.
	CR0-7003	305.00	C Service for CESAL5SE extinguishing system. Not activated bottle.
CESAL5 LE			
	CR0-8002	759.00	C Service for CESAL5LE extinguishing system. Activated bottle.
	CR0-8003	305.00	C Service for CESAL5LE extinguishing system. Not activated bottle.
CEFAL3			
	CR0-4810	406.00	C Replacement liquid , suction pipe, bottle, valve CEFAL3.
	CR0-4808	303.00	C Replacement liquid , suction pipe, valve CEFAL3.
	CR0-4806	247.00	C Replacement liquid, suction pipe, priming plug, small percussion pin, spring CEFAL3.
	CR0-4809	247.00	C Replacement liquid , suction pipe, bottle CEFAL3.
	CR0-4807	116.00	C Replacement liquid , suction pipe CEFAL3.
CESAL3			
	CR0-4805	402.00	C Replacement liquid , suction pipe, bottle, valve CESAL3.
	CR0-4803	299.00	C Replacement liquid, suction pipe, valve CESAL3.
	CR0-4804	253.00	C Replacement liquid , suction pipe, bottle CESAL3.
	CR0-4801	247.00	C Replacement liquid, suction pipe, priming plug, small percussion pin, spring CESAL3.
	CR0-4802	121.00	C Replacement liquid, suction pipe CESAL3.
CEFAL2 / CESAL3R			
	CR0-4607	281.00	C Replacement liquid 2.8l, dip tube, valve CB/366, CEFAL2 and CESAL3R.
	CR0-4601	235.00	C Replacement liquid 2.8l, dip tube, priming plug, small percussion pin, spring CB/366, CEFAL2 and CESAL3R.
	CR0-4504	225.00	C Replacement liquid 2.8l, bottle CB/366, CEFAL2 and CESAL3R.
	CR0-4308	156.00	C Replacement liquid 2.8l, dip tube, percussion pin, spring, valve body CB/366, CEFAL2 and CESAL3R.
	CR0-4201	116.00	C Replacement liquid 2.8l, dip tube CB/366, CEFAL2 and CESAL3R.
CESAL2			
	CR0-4706	318.00	C Replacement liquid 4.2l, dip tube, bottle CB/367 and CESAL2.
	CR0-4705	308.00	C Replacement liquid 4.2l, dip tube, valve CB/367 and CESAL2.
	CR0-4701	267.00	C Replacement liquid 4.2l, dip tube, priming plug, small percussion pin, spring CB/367 and CESAL2.
	CR0-4503	196.00	C Replacement liquid 4.2l, dip tube, percussion pin, CB/367 e CESAL2.
	CR0-4402	155.00	C Replacement liquid 4.2l, dip tube CB/367 and CESAL2.
CMSST1			
	CR0-4404	143.00	C Replacement liquid 4.2l, dip tube, bottle CA/303 and CMSST1.
	CR0-4403	141.00	C Replacement liquid 4.25l, valve CA/303 and CMSST1.
	CR0-4304	133.00	C Replacement liquid 4.25l, dip tube CA/303 and CMSST1.
	CR0-4306	129.00	C Replacement valve CA/303 and CMSST1.
	CR0-4200	67.00	C Replacement liquid 4.25l CA/303 and CMSST1.
CMFST1			
	CR0-4400	142.00	C Replacement liquid 2.8l, dip tube, bottle CA/305 and CMFST1.
	CR0-4305	125.00	C Replacement liquid 2.8l, valve CA/305 and CMFST1.
	CR0-4301	116.00	C Replacement liquid 2.8l, dip tube CA/305 and CMFST1.
	CR0-4105	82.00	C Replacement liquid 2.8l CA/305 and CMFST1.
	CR0-4202	54.00	C Replacement valve CA/305 and CMFST1.
CESST1			
	CR0-4704	308.00	C Replacement liquid 4.25l, dip tube, valve CA/369 and CESST1.
	CR0-4700	260.00	C Replacement liquid 4.25l, dip tube, priming plug, small percussion pin, spring CA/369 and CESST1.
	CR0-4502	186.00	C Replacement liquid 4.25l, dip tube, percussion pin, spring, valve body CA/369 and CESST1.
	CR0-4500	182.00	C Replacement liquid 4.25l, dip tube, bottle CA/369 and CESST1.
	CR0-4401	143.00	C Replacement liquid 4.25l, dip tube CA/369 and CESST1.
OLD SYSTEMS			
	CR0-4800	405.00	C Replacement liquid 4.2l, dip tube, bottle CB/363
	CR0-4703	300.00	C Replacement liquid 4.2l, dip tube, valve CB/363
	CR0-4702	274.00	C Replacement liquid 4.25l, dip tube, valve CB/363
	CR0-4605	244.00	C Replacement liquid 4.2l, dip tube, percussion valve, spring, pirotechnic igniter CB/363
	CR0-4406	163.00	C Replacement liquid 4.2l, dip tube CB/363
	CR0-4303	119.00	C Replacement pirotechnic igniter CB/363
	CR0-4608	276.00	C Replacement liquid 2.8l, dip tube, bottle CA/364
	CR0-4606	267.00	C Replacement liquid 2.8l, dip tube, valve CB/364
	CR0-4501	253.00	C Replacement liquid 2.8l, dip tube, percussion valve, spring, pirotechnic igniter CB/364
	CR0-4309	158.00	C Replacement liquid 2.8l, dip tube CB/364
	CR0-4300	98.00	C Replacement pirotechnic igniter CB/364
	CR0-4603	253.00	C Replacement liquid 2.8l, dip tube, valve CB/365
	CR0-4602	234.00	C Replacement liquid 2.8l, dip tube, bottle CB/365
	CR0-4600	230.00	C Replacement liquid 2.8l, dip tube, priming plug, small percussion pin, spring CB/365
	CR0-4307	156.00	C Replacement liquid 2.8l, dip tube, percussion pin, spring, valve body CB/365
	CR0-4203	107.00	C Replacement liquid 2.8l, dip tube CB/365
	CR0-4604	235.00	C Replacement liquid 4.25l, dip tube, percussion valve, spring, pirotechnic igniter CA/304
	CR0-4505	204.00	C Replacement liquid 4.25l, dip tube, bottle CA/304
	CR0-4405	163.00	C Replacement liquid 4.25l, dip tube CA/304

R	Ref	Euro	Description
	CR0-4302	119,00	C Replacement pirotechnic igniter CA/304
HAND HELD SERVICING			
	CR0-4910	203,00	C Service for CAB/323 extinguishing system. Activated bottle.
	CR0-4911	56,00	C Service for CAB/323 extinguishing system. Not activated bottle.
	CR0-4106	102,00	C Replacement liquid 2.4l. valve, pipe, pressure gauge CBB/351
	CR0-4103	85,00	C Replacement valve and pressure gauge CBB/351
	CR0-4102	56,00	C Replacement liquid 2.4l CBB/351
	CR0-4104	102,00	C Replacement liquid 2.4l. valve, pipe, pressure gauge CAB/319
	CR0-4101	85,00	C Replacement valve and pressure gauge CAB/319
	CR0-4100	56,00	C Replacement liquid 2.4l CAB/319

STEERING WHEELS

Descriptive List

R	Ref	Euro	Description	Colour	Handle	Diam	Depth
RACING STEERING WHEELS							
	OD0-2048	1.350,00	D 320 Hybrid S: Flat steering wheel made with a new exclusive composite technology (carbon fiber and Dyneema®) 300% more resistant than the carbon steering wheel and 20% lighter. Prepared to install 4 bottoms (not included), supplied with horn button. Realized and developed in cooperation with Sébastien Ogier, WRC world champion with VW Motorsport.	Black in suede leather (OD0-2048-071)	oval, 35x24 mm	320 mm	flat
	OD0-2032	780,00	C 320 CARBON S: Superlight professional steering wheel, 3 spokes. In suede leather, carbon made spokes, black stitching. Carbon steering wheel is constructed as one integral piece. Following all the suggestions of the Rally world champion Petter Solberg. Supplied with horn button. Weight 460 gr.	Black in suede leather (OD0-2032-071)	oval, 35x24 mm	320 mm	flat
	OD0-2028	650,00	C 350 CARBON D: Carbon dished steering wheel, in suede leather and carbon made spokes. Black stitching. Carbon steering wheel is constructed as one integral piece. Supplied with horn button. Depth 95 mm. Weight 500 gr.	Black in suede leather (OD0-2028-071)	round, 30 mm	350 mm	dished
	OD0-2044	450,00	C 310 ALU GT: Flat steering wheel with aluminium spokes and suede leather handgrip for GT cars. With italian flag coloured stitching. The new design of the spokes allow the mounting of electronic dashboards (compatible with MoTec C125 e AiM MXL)	Black in suede leather (OD0-2044-071)	oval, 36x30 mm	315 mm	flat
	OD0-2034	320,00	C CORSICA OV SUPERLEGGERO: dished steering wheel with 3 black anodized aluminium spokes, in suede leather, black stitching. Supplied with horn button. Depth 95 mm.	Black in suede leather (OD0-2034-071)	oval, 39x19 mm	350 mm	dished
	OD0-2035	320,00	C VELOCITA' OV SUPERLEGGERO: Flat steering wheel with 3 black anodized aluminium spokes, in suede leather, black stitching. Supplied with horn button.	Black in suede leather (OD0-2035-071)	oval, 39x19 mm	320mm	flat
	OD0-2046	280,00	C RECCE: Flat steering wheel in aluminium, 350 mm diameter, round 30 mm handgrip. With colored marks on the crown to indicate steering wheel angles (0° - 25° - 55° - 100° - 160°)	Black in suede leather (OD0-2046-071)	round, 30 mm	350 mm	flat
	OD0-2020	270,00	C VELOCITA' SUPERLEGGERO: Suede leather aluminium steering wheel, 40% lighter than equal model Velocità. Black stitching. Supplied with horn button.	Black in suede leather (OD0-2020-071)	round, 30 mm	350 mm	flat
	OD0-2021	270,00	C CORSICA SUPERLEGGERO: Suede leather aluminium steering wheel, handgrip 40% lighter than equal model CORSICA. Black stitching. Supplied with horn button. Depth 95 mm.	Black in suede leather (OD0-2021-071)	oval, 30x28 mm	350 mm	dished
	OD0-2042-A01	270,00	C 320 ALU S: New three spokes flat aluminium steering wheel in suede leather. Shaped handgrip and spokes to improve driving feeling and comfort. Two red buttons mounted on horizontal spokes controlling two separate accessory switches (for example one for horn and the other for highbeams)	Black in suede leather (OD0-2042-A01-071)	oval, 35x24 mm	320 mm	flat
	OD0-2042-A02	270,00	C 320 ALU SP: New three spokes flat aluminium steering wheel in suede leather. Shaped handgrip and spokes to improve driving feeling and comfort. Two red buttons mounted on horizontal spokes controlling two separate accessory switches (for example one for horn and the other for highbeams). With central hole.	Black in suede leather (OD0-2042-A02-071)	oval, 35x24 mm	320 mm	flat
N	OD0-2042-A03	270,00	C 320 Alu Rally: Three spokes flat aluminium steering wheel in suede leather. Shaped handgrip and spokes to improve driving feeling and comfort. Lightweight materials.	Black in suede leather (OD0-2042-A03-071)	oval, 35x24 mm	320 mm	flat
	OD0-1985	230,00	C KUBIC: Flat steering wheel in suede leather. 3 anodized aluminium spokes with a flat upper and lower crown. Black stitching. Derived from our experience gained in professional Touring car competitions. Supplied with horn button. Very extreme and aggressive look.	Black in suede leather (OD0-1985-071)	oval, 35x28 mm	310x265 mm	flat
	OD0-2017	225,00	C INDY OPEN: Steering wheel for single, with black anodized spokes and rim in suede leather. Black stitching. Open center for inserting instruments.	Black in suede leather (OD0-2017-071)	oval, 35x25 mm	250x170 mm	single

R	Ref	Euro		Description	Colour	Handle	Diam	Depth
	OD0-1957	210,00	C	VELOCITA' : Flat steering wheel, in smooth leather, with 3 black anodized aluminium spokes. Supplied with horn button. Yellow stitching.	Black in smooth leather (OD0-1957-071)	oval, 30x25 mm	350 mm	flat
	OD0-1987	210,00	C	VELOCITA' 380 : Flat steering wheel, in suede leather, with 3 black anodized aluminium spokes. Supplied with horn button.	Black in suede leather (OD0-1987-071)	oval, 35x30 mm	380 mm	flat
	OD0-2012	210,00	C	CORSICA 330 : dished steering wheel with 3 black anodized aluminium spokes. Supplied with horn button. Yellow stitching.	Black in suede leather (OD0-2012-071)	oval, 30x25 mm	330 mm	dished
	OD0-2030	210,00	C	VELOCITA' 380 : Flat steering wheel, in smooth leather, with 3 black anodized aluminium spokes. Supplied with horn button. Black stitching.	Black in suede leather (OD0-2030-071)	oval, 35x30 mm	380 mm	flat
	OD0-1954	199,00	C	CORSICA : Dished steering wheel with 3 anodized aluminium spokes. Supplied with horn button. In suede leather. Yellow stitching. Depth 95 mm.	Black in suede leather with black spokes (OD0-1954-071) Black in suede leather with titanium spokes (OD0-1954-371) Black in suede leather with blue spokes (OD0-1954-240) Black in suede leather with black spokes and red details (OD0-1954-073)	oval, 30x28 mm	350 mm	dished
	OD0-1958	199,00	C	VELOCITA' : Flat steering wheel, in suede leather, with 3 black anodized aluminium spokes. Supplied with horn button. Black stitching.	Black in suede leather (OD0-1958-071)	oval, 30x25 mm	350 mm	flat
	OD0-1980	199,00	C	WRC : Dished steering wheel with 3 black anodized spokes. In smooth leather. Yellow stitching. Supplied with horn button. Depth 70 mm.	Black in suede leather (OD0-1958-071) Black/red in suede leather (OD0-1958-073)	round, 30 mm	350 mm	mid-dept dished
	OD0-1990	195,00	C	SUPERQUADRO : Flat steering wheel, in suede leather, with 3 black anodized spokes. Black suede anatomical handgrip with flat bottom design. Supplied with horn button. Yellow stitching.	Black in suede leather (OD0-1990-071)	oval, 35x27 mm	330x290 mm	flat
	OD0-1956	189,00	C	CORSICA : Dished steering wheel with 3 anodized aluminium spokes. Supplied with horn button. In suede leather. Yellow stitching (OD/1956/N and OD/1956/AN) and red (OD/1956/NR). Depth 95 mm.	Black in suede leather (OD0-1956-071) Black in suede leather with silver spokes (OD0-1956/AN) Black Black in suede leather with red details (OD0-1956-073)	oval, 30x28 mm	350 mm	dished
	OD0-1979	189,00	C	WRC : Dished steering wheel with 3 black anodized spokes. In suede leather. Black stitching. Supplied with horn button. Depth 70 mm.	Black in suede leather (OD0-1979-071)	round, 30 mm	350 mm	mid-dept dished
	OD0-1976	185,00	C	TRECENTO : Flat steering wheel. 3 anodized aluminium spokes with lower offset to improve instrument cluster visibility. In smooth leather. Black stitching. Supplied with horn button.	Black in suede smooth (OD0-1976-071)	oval, 37x27 mm	300 mm	flat
	OD0-2005	185,00	C	TARGA 330 : Flat steering wheel, in suede leather, with 3 black anodized spokes. Supplied with horn button. Black stitching.	Black in suede leather (OD0-2005-071)	oval, 37x24 mm	330 mm	flat
	OD0-1950	175,00	C	RALLY : Dished steering wheel, in smooth leather, with 2 black anodized aluminium spokes. Supplied with horn button. Depth: 95 mm. Yellow stitching	Black in smooth leather (OD0-1950)	round, 30 mm	350 mm	dished
	OD0-1951	175,00	C	RALLY : Dished steering wheel, in suede leather, with 2 black anodized aluminium spokes. Supplied with horn button. Depth: 95 mm.	Black in suede leather (OD0-1951) Black in suede leather with blue spokes (OD0-1951-240)	round, 30 mm	350 mm	dished
	OD0-1972	175,00	C	FORMULA QUADRO : Flat steering wheel, for single, in suede leather with 3 black anodized spokes. Black stitching. Flat bottom design and anatomical grip. Allows driver's legs greater freedom of movement.	Black in suede leather (OD0-1972-071)	oval, 35x25 mm	250x230 mm	single
	OD0-1975	175,00	C	TRECENTO : Flat steering wheel. 3 anodized aluminium spokes with lower offset to improve instrument cluster visibility. In suede leather. Black stitching. Supplied with horn button.	Black in suede leather (OD0-1975-071)	oval, 37x27 mm	300 mm	flat
	OD0-2055	165,00	C	RS : Entry level mid-depth dished steering wheel with three aluminium spokes. Round handgrip in black suede leather, yellow viewfinder. Horn button included.	Black in suede leather (OD0-2055-071)	round, 30 mm	350 mm	mid-dept dished

TUNING STEERING WHEELS

R	Ref	Euro		Description	Colour	Handle	Diam	Depth
	OD0-2018	139,00	A	CROMO: Flat steering wheel with 3 chrome spokes in smooth leather with perforated leather inserts design with anatomic handgrips. Black stitching. Complete with horn button.	Black in smooth leather (OD/2018-189)	oval, 32x27	350x330 mm	flat
	OD0-2019	139,00	A	ASSO: Flat steering wheel with 3 chrome spokes in smooth leather design with anatomic handgrips. Black stitching. Complete with horn button.	Black in smooth leather (OD-2019-189)	oval, 35,5x27 mm	350 mm	flat
	OD0-1981	129,00	A	RACING GP: Flat steering wheel with 3 anodized spokes, anti-skid polyurethane handgrip, simulating perforated leather for enhanced grip, black stitching. Supplied with horn button.	Black in polyurethane (OD0-1981-071)	oval, 37x27 mm	330 mm	flat
	OD0-1989	129,00	A	TRECENTO UNO: Flat steering wheel with 3 black spokes, anti-skid polyurethane handgrip, simulating perforated leather for enhanced grip, black stitching. Supplied with horn button.	Black in polyurethane (OD0-1989-071)	oval, 37x27 mm	300 mm	flat
VINTAGE STEERING WHEELS								
	OD0-2023	109,00	C	MUGELLO: Wooden steering wheel.	Aluminium/wooden (OD0-2023-019)	round, 30 mm	350 mm	flat
OFF ROAD STEERING WHEELS								
	OD0-2031	149,00	C	SAND: Flat steering wheel, 3 spokes, in poliuretane, black stitching, black anodized spokes. Supplied with horn button.	Black in polyurethane (OD0-2031-071)	round, 30 mm	380 mm	flat
STEERING WHEEL ACCESSORIES								
	OS0-0024-A04	419,00	C	Quick release hub to be welded in aluminium with 6 holes. Compatible with 3 or 6 holes steering wheel. Recommended to be use PTFE dry lube to get the best performance and preserve all components. 11 pin professional electrical connector included. This part is an high performance interconnection engineered with arc-shape metal guides, which ensure a rapid and precise alignment of the 11 contacts. Aluminium body, IP68 sealing, 10000 cycles guarantee, high temperature and chemical resistance. Dimension: diameter 109mm, lenght 73mm (closed)				
	OS0-0024-A02	409,00	C	Quick release hub to be bolted in aluminium with 6 holes. Compatible with 3 or 6 holes steering wheel. Recommended to be use PTFE dry lube to get the best performance and preserve all components. 11 pin professional electrical connector included. This part is an high performance interconnection engineered with arc-shape metal guides, which ensure a rapid and precise alignment of the 11 contacts. Aluminium body, IP68 sealing, 10000 cycles guarantee, high temperature and chemical resistance. Dimension: diameter 109mm, lenght 39mm (closed)				
	OS0-0025-A02	264,00	C	6 holes quick release hub in aluminium. With 'butterfly' handgrip shape to avoid interaction with shift paddle. Compatible with 3 or 6 holes steering wheels. To be welded version. Dimension: 109mmx72mm, lenght 73mm (closed)				
	OS0-0024-A03	259,00	C	Quick release hub to be welded in aluminium with 6 holes. Compatible with 3 or 6 holes steering wheel. Recommended to be use PTFE dry lube to get the best performance and preserve all components. Dimension: diameter 109mm, lenght 73mm (closed)				
	OS0-0025-A01	244,00	C	6 holes quick release hub in aluminium. With 'butterfly' handgrip shape to avoid interaction with shift paddle. Compatible with 3 or 6 holes steering wheels. To be bolted version. Dimension: 109mmx72mm, lenght 39mm (closed)				
	OS0-0024-A01	234,00	C	Quick release hub to be bolted in aluminium with 6 holes. Compatible with 3 or 6 holes steering wheel. Recommended to be use PTFE dry lube to get the best performance and preserve all components. Dimension: diameter 109mm, lenght 39mm (closed)				

R	Ref	Euro	Description	Colour	Handle	Diam	Depth
	OD0-2052-B01	146,00	C Universal face protection for steering wheel. Suede leather upholstery, it fits on any racing steering wheel thanks to the three adjustable velcro's straps. Made in ultralight CONFOR™ foam CF45M (blue) in compliance with FIA Appendix J Article 285 (revision August 2020). Depth: 40mm, Diameter: 160mm.				
	OD0-2026	114,00	C Button holder plate for steering wheel, in carbon, thickness 2.5 mm, can be used maximum with 4 buttons (not provided). The 6 holes allow the fixing between steering wheel and steering wheel hub (fixing screws provided)	Carbon fiber			
	OD0-2029	88,00	C Carbon button holder plate for steering wheels. Thickness 2.5 mm. 2 buttons included. 2 drill points for attachment between steering wheel and hub. Fixing screws included.	Carbon fiber			
	OD0-1960	14,00	A Horn button				
	XMO-1960	5,20	A Mounting hardware for steering wheel boss.				
RACING STEERING WHEEL SPACERS							
	OS0-0023	119,00	A Steering wheel spacer. Depth 60mm.	Black (OS0-0023-071) Silver (OS0-0023-081)			

STEERING WHEEL HUBS

Application List

R Ref	Euro	Car	Airbag	Year	Collap.	A. Alarm	N° Splines	Diam.
ALFA ROMEO								
OD0-1960-AL13-2	86,00	A	33	>83<89	X		36	16,5
OD0-1960-AL17-1	76,00	A		>90>94	X		36	16,5
OD0-1960-AL13-2	86,00	A	75	>85<92	X		36	16,5
OD0-1960-AL13-2	86,00	A	90	>84<88	X		36	16,5
OD0-1960-FI20	76,00	A	145	>94	X		37	16,5
OD0-1960-FI20	76,00	A	146	>95	X		37	16,5
OD0-1960-FI769A	95,00	A	147	airbag >00	X	X	37	16,5
OD0-1960-FI20	76,00	A	155	>1/92	X		37	16,5
OD0-1960-FI25	96,00	A	156	>97	X		37	16,5
OD0-1960-FI769A	95,00	A	159	airbag >05	X	X	37	16,5
OD0-1960-AL17	72,00	A	164	>09/87			36	16,5
OD0-1960-AL948	95,00	A	166	airbag >98<07	X	X	37	16,5
OD0-1960-AL16	76,00	A	ALFETTA (striped)	>82<84			36	16,5
OD0-1960-AL16	76,00	A	GIULIETTA (striped)	>81<85			36	16,5
OD0-1960-FI769A	95,00	A		airbag >10	X	X	37	16,5
OD0-1960-FI769A	95,00	A	GT	airbag >03	X	X	37	16,5
OD0-1960-AL825	82,00	A	GIULIA (key)	>75			KEY	-
OD0-1960-FI769A	95,00	A	GIULIA	airbag >16	x	X	37	16,5
OD0-1960-AL824	82,00	A	GT JUNIOR (key)	>73<77			KEY	-
OD0-1960-AL825	82,00	A	GTV (key)	>76<86			KEY	-
OD0-1960-AL16	76,00	A	GTV 2000	>81<94			36	16,5
OD0-1960-AL16	76,00	A	GT V6	>81<87			36	16,5
OD0-1960-FI26	82,00	A	GTV/GTV SPIDER	>94	X		36	16,5
OD0-1960-FI769A	95,00	A	MITO	airbag >06/08	X	X	37	16,5
OD0-1960-AL948	95,00	A	SPIDER GT	airbag >94	X	X	37	16,5
OD0-1960-AL824	82,00	A	SPIDER-DUETTO (key)	<79			KEY	-
OD0-1960-AL825	82,00	A		>80<85			KEY	-
OD0-1960-AL825	82,00	A		>86<89			KEY	-
OD0-1960-AL13	82,00	A	SPIDER-DUETTO (striped)	>90<04/95			36	16,5
AUDI								
OD0-1960-VW145	86,00	A	80 - 80 TURBO DIESEL	>79<8/86	X		40	16,7
OD0-1960-AU147	86,00	A	80	>09/86<94	X		40	16,7
OD0-1960-VW145	86,00	A	90	>79<8/86	X		40	16,7
OD0-1960-AU147	86,00	A		>09/86<91	X		40	16,7
OD0-1960-AU147	86,00	A	100	>83<94	X		40	16,7
OD0-1960-AU147	86,00	A	200 (5000 TURBO)	>12/83<91	X		40	16,7
OD0-1960-AU147	86,00	A	5000 QUATTRO TURBO	>85	X		40	16,7
OD0-1960-VW239A	95,00	A	A1	airbag >10	X	X	86	25,25
OD0-1960-VW237A	95,00	A	A3	airbag >98<12/04	X	X	86	25,25
OD0-1960-VW239A	95,00	A		airbag >05	X	X	86	25,25
OD0-1960-AU951	105,00	A	A4	airbag >95<97	X	X	40	16,7
OD0-1960-VW237A	95,00	A		airbag >98<12/04	X	X	86	25,25
OD0-1960-AU976	105,00	A		airbag >11<19	X	X	86	25,25
OD0-1960-AU976	105,00	A	A5	airbag >11<19	X	X	86	25,25
OD0-1960-AU951	105,00	A	A6	airbag <97	X	X	40	16,7
OD0-1960-AU976	105,00	A		airbag >11<19	X	X	86	25,25
OD0-1960-VW145	86,00	A	COUPE'	>81<89	X		40	16,7
OD0-1960-AU147	86,00	A		>90<94	X		40	16,7
OD0-1960-VW853	86,00	A	QUATTRO				40	16,7
OD0-1960-AU976	105,00	A	R8	airbag >11<19	X	X	86	25,25
OD0-1960-AU951	105,00	A	S4	airbag <98	X	X	40	16,7
OD0-1960-AU951	105,00	A	S6	airbag <97	X	X	40	16,7
OD0-1960-VW237A	95,00	A	TT - ROADSTER	airbag >98	X	X	86	25,25
OD0-1960-AU147	86,00	A	V8	>89<94	X		40	16,7
AUTOBIANCHI								
OD0-1960-LA10-1	86,00	A	Y 10	>85<91			37	16,5
OD0-1960-FI21	76,00	A		>92<12/92	X		37	16,5
OD0-1960-FI10	72,00	A		>93<95			37	16,5
BLMC (MORRIS - AUSTIN)								
OD0-1960-BL846	76,00	A	MAESTRO - MONTEGO - METRO				48	18,2
BMW								
OD0-1960-BM828	82,00	A	3.0 - SI - CSI - 3.3				36	16,5
OD0-1960-BM828	82,00	A	316 - 318 - 320 - 323	<08/83			36	16,5
OD0-1960-BM829	82,00	A	518 - 520 - 525 - 525 TD - 528	>09/83<08/85			36	16,5
OD0-1960-BM828	82,00	A	518 - 520 - 525 - 528	>78<08/82			36	16,5
OD0-1960-BM828	82,00	A	728 - 730 - 735 - 745	<08/86			36	16,5
OD0-1960-BM23-1	76,00	A	SERIES 3 E30	>09/83<90	X		52	16,5
OD0-1960-BM25	82,00	A	SERIES 3	>91<93	X		66	20,7
OD0-1960-BM547A	105,00	A	SERIES 3 E36	airbag >90<94	X	X	66	20,7

Remark

N = New

NV = Variation

Years

> Major of

< Minor of

R Ref	Euro		Car	Airbag	Year	Collap.	A. Alarm	N° Splines	Diam.
ODO-1960-BM545A	105,00	A		airbag	>95<01		X	66	20,7
ODO-1960-BM789A	95,00	A	SERIES 3 E46	airbag	>98<06		X	66	20,7
ODO-1960-BM789A	95,00	A	SERIES 3 E90 (M3 excluded)	airbag	>05		X	66	20,7
ODO-1960-BM23-1	76,00	A	SERIES 5		>09/85<95	X		52	16,5
ODO-1960-BM25	82,00	A		airbag	>92<01	X	X	66	20,7
ODO-1960-BM545A	105,00	A	SERIES 5 E39	airbag	>96<03		X	66	20,7
ODO-1960-BM962	115,00	A	SERIES 5 E60	airbag	>03<10	X	X	66	21,50
ODO-1960-BM828	82,00	A	SERIES 6		<08/83			36	16,5
ODO-1960-BM829	82,00	A			>09/83<86			36	16,5
ODO-1960-BM23-1	76,00	A			>87<89	X		52	16,5
ODO-1960-BM23-1	76,00	A	SERIES 7		>09/86<94	X		52	16,5
ODO-1960-BM25	82,00	A	SERIES 8		>91<96	X		66	20,7
ODO-1960-BM23-1	76,00	A	Z1		>86<01	X		52	16,5
ODO-1960-BM545A	105,00	A	Z3	airbag	>95<02		X	66	20,7
ODO-1960-BM789A	95,00	A	Z4 E85 E86 E89	airbag	>02<16		X	66	20,7
CITROEN									
ODO-1960-CI134	76,00	A	AX		>87<08/91			40	16,7
ODO-1960-CI139	76,00	A			>09/91	X		40	16,7
ODO-1960-CI141	95,00	A	BERLINGO		>97	X		40	16,7
ODO-1960-CI786A	95,00	A	C1	airbag	>06	X	X	33	15,25
ODO-1960-CI144A	105,00	A	C2	airbag	>03	X	X	33	16,4
ODO-1960-CI144A	105,00	A	C3	airbag	>02	X	X	33	16,4
ODO-1960-CI981	105,00	A		airbag	>17	X	X	33	16,4
ODO-1960-CI144A	105,00	A	DS3	airbag	>10	X	X	33	16,4
ODO-1960-CI968	105,00	A	DS4	airbag	>11<14	X	X	33	16,4
ODO-1960-CI968	105,00	A	DS5	airbag	>11<14	X	X	33	16,4
ODO-1960-CI944	76,00	A	EVASION		>10/94	X		40	16,7
ODO-1960-CI140	76,00	A	SAXO		>96<98	X		40	16,7
ODO-1960-CI143A	105,00	A		airbag	>99	X	X	40	16,7
ODO-1960-PE91-2	76,00	A	XANTIA		>93	X		40	16,7
ODO-1960-CI965	76,00	A	XM		>90	X			
ODO-1960-CI780A	105,00	A	XSARA	airbag		X	X	40	16,7
ODO-1960-CI139	76,00	A	ZX		>06/91	X		40	16,7
DACIA									
ODO-1960-RE114A	95,00	A	SANDERO	airbag	>13	X	X	33	16,4
DAEWOO									
ODO-1960-OP72	86,00	A	ESPERO		>94<96	X		36	15
ODO-1960-DE5792	76,00	A	LANOS	airbag	>97	X	X	36	15
ODO-1960-OP72	86,00	A	LE MANS			X		36	15
ODO-1960-DE770	76,00	A	MATIZ		>99	X		36	15
ODO-1960-OP72	86,00	A	NEXIA		>94<96	X		36	15
ODO-1960-DE5791	76,00	A			>97	X		36	15
ODO-1960-OP72	86,00	A	NUBIRA		>97	X		36	15
ODO-1960-OP72	86,00	A	PRICE			X		36	15
DAIHATSU									
ODO-1960-DA383	76,00	A	APPLAUSE		>07/89			33	15,25
ODO-1960-DA383	76,00	A	CHARADE		>87			33	15,25
ODO-1960-DA383	76,00	A	FEROZA		>89			33	15,25
ODO-1960-DA383	76,00	A	ROCKY		>93			33	15,25
FERRARI									
ODO-1960-FI769A	95,00	A	F430		>04<09			37	16,5
FIAT									
ODO-1960-YU508	86,00	A	126		>03/78<83			20	16,25
ODO-1960-YU508	86,00	A	127		>03/78<84			20	16,25
ODO-1960-YU508	86,00	A	147		>03/78<84			20	16,25
ODO-1960-FI818	86,00	A	500		<75			38	18,2
ODO-1960-FI790A	95,00	A		airbag	>07	X	X	37	16,5
ODO-1960-FI811	95,00	A	500 ABARTH	airbag	>07<15	X	X	37	16,5
ODO-1960-FI818	86,00	A	600		<75			38	18,2
ODO-1960-FI949	105,00	A		airbag	>98<01	X	X	37	16,5
ODO-1960-FI25	96,00	A	BARCETTA		>95	X		37	16,5
ODO-1960-FI25	96,00	A	BRAVA		>09/95	X		37	16,5
ODO-1960-FI25	96,00	A	BRAVO		>09/95	X		37	16,5
ODO-1960-FI769A	95,00	A		airbag	>07	X	X	37	16,5
ODO-1960-YU508	86,00	A	CAMPAGNOLA					20	16,25
ODO-1960-FI24	82,00	A	CINQUECENTO		>03/92<97	X		37	16,5
ODO-1960-FI771	76,00	A	CINQUECENTO SPORTING	airbag	>98<00	X	X	37	16,5
ODO-1960-FI802	82,00	A	CITY BRASIL					20	16,25
ODO-1960-FI26	82,00	A	COUPE'		>94	X		36	16,5
ODO-1960-FI769A	95,00	A	DOBLO'	airbag	>10/99	X	X	37	16,5
ODO-1960-YU508	86,00	A	FIORINO		<10/84			20	16,25
ODO-1960-FI804	86,00	A			>11/84<89	X		37	16,5
ODO-1960-FI04	82,00	A	FIORINO PICK-UP		>92			37	16,5
ODO-1960-FI21	76,00	A			>93	X		37	16,5

R Ref	Euro		Car	Airbag	Year	Collap.	A. Alarm	N° Splines	Diam.
ODO-1960-YU508	86,00	A	FURGONE 850T					20	16,25
ODO-1960-FI783A	95,00	A	GRANDE PUNTO	airbag	>06	X	X	60	20,5
ODO-1960-FI769A	95,00	A	IDEA	airbag	>04	X	X	37	16,5
ODO-1960-FI25	96,00	A	MAREA		>96	X		37	16,5
ODO-1960-AL948	95,00	A	MULTIPLA	airbag	<05/04	X	X	37	16,5
ODO-1960-FI769A	95,00	A		airbag	>06/04	X	X	37	16,5
ODO-1960-FI802	82,00	A	PANDA 1st series		<10/84			20	16,25
ODO-1960-FI804	86,00	A	PANDA 2nd series		>11/84	X		37	16,5
ODO-1960-FI769A	95,00	A	PANDA 3rd series	airbag	>05	X	X	37	16,5
ODO-1960-FI25	96,00	A	PUNTO 1st series		>11/93<09/99	X		37	16,5
ODO-1960-FI769A	95,00	A	PUNTO 2nd series	airbag	>10/99	X	X	37	16,5
ODO-1960-FI783A	95,00	A	PUNTO EVO ABARTH	airbag	>10	X	X	60	20,5
ODO-1960-CI944	76,00	A	SCUDO			X		40	16,7
ODO-1960-FI771	76,00	A	SEICENTO SPORTING	airbag	>01	X	X	37	16,5
ODO-1960-FI769A	95,00	A	STILO	airbag	>99	X	X	37	16,5
ODO-1960-FI20	76,00	A	TEMPRA		>90	X		37	16,5
ODO-1960-FI20	76,00	A	TIPO		>01/88	X		37	16,5
ODO-1960-CI944	76,00	A	ULYSSE		>10/94	X		40	16,7
ODO-1960-FI04	82,00	A	UNO 1st series		>83<89			37	16,5
ODO-1960-FI10	72,00	A	UNO 2nd series		>90<02/92	X		37	16,5
ODO-1960-FI21	76,00	A	UNO 3rd series		>03/92<94	X		37	16,5
ODO-1960-FI827	82,00	A	X 1/9		>03/78<88			20	16,25
FORD									
ODO-1960-FO29	82,00	A	ESCORT*		>75<08/80			40	16,7
ODO-1960-FO32	76,00	A	*		>09/80<03/86			HEXAGON	-
ODO-1960-FO36	76,00	A	*		>04/86<09/89			HEXAGON	-
ODO-1960-FO36-1	76,00	A	*		>10/89			HEXAGON	-
ODO-1960-FO36-2	86,00	A	ESCORT - COSWORTH*		>91<96	X		HEXAGON	-
ODO-1960-FO541	95,00	A		airbag	>96	X	X	HEXAGON	-
ODO-1960-FO831	86,00	A	FIESTA 2nd series		>09/83<06/89			HEXAGON	-
ODO-1960-FO539	86,00	A	FIESTA 3rd series		>07/89<94	X		HEXAGON	-
ODO-1960-FO541	95,00	A	FIESTA 4th series	airbag	>95<11/04	X	X	HEXAGON	-
ODO-1960-FO542A	95,00	A	FIESTA 5th series	airbag	>04<11/08	X	X	HEXAGON	-
ODO-1960-FO969	105,00	A	FIESTA 6th series	airbag	>08<16	X	X	HEXAGON	-
ODO-1960-FO969	105,00	A	FIESTA 7th series	airbag	>01/07	X	X	HEXAGON	-
ODO-1960-FO542A	95,00	A	FOCUS	airbag	>98<04	X	X	HEXAGON	-
ODO-1960-FO32-1	76,00	A	GRANADA		>82			HEXAGON	-
ODO-1960-FO539	86,00	A	KA 1st series		>96<97	X		HEXAGON	-
ODO-1960-FO541	95,00	A		airbag	>97	X	X	HEXAGON	-
ODO-1960-FO542A	95,00	A	MONDEO	airbag	>01	X	X	HEXAGON	-
ODO-1960-FO542A	95,00	A	MUSTANG GT	airbag	>07	X	X	HEXAGON	-
ODO-1960-FO32	76,00	A	ORION		>09/80<03/86			HEXAGON	-
ODO-1960-FO36	76,00	A			>04/86<09/90			HEXAGON	-
ODO-1960-FO36-2	86,00	A			>10/90<93	X		HEXAGON	-
ODO-1960-FO541	95,00	A	PUMA	airbag	>97	X	X	HEXAGON	-
ODO-1960-FO36	76,00	A	SCORPIO		>03/86<94			HEXAGON	-
ODO-1960-FO32	76,00	A	SIERRA 1300*		>10/82<01/94			HEXAGON	-
ODO-1960-FO32-1	76,00	A	SIERRA 1600 - GHIA*		<01/94			HEXAGON	-
ODO-1960-FO32-1	76,00	A	SIERRA COSWORTH*		<01/94			HEXAGON	-
ODO-1960-FO922	86,00	A	TE CORTINA 1.6 - 2.0		>76<80	X		40	16,7
ODO-1960-FO542A	95,00	A	TRANSIT - CONET	airbag	>06	X	X	HEXAGON	-
HOLDEN									
ODO-1960-TO295	76,00	A	APOLLO			X		33	15,25
ODO-1960-NI310	76,00	A	ASTRA			X		34	14,55
ODO-1960-HL870	76,00	A	BARINA					30	13,4
ODO-1960-HL876	76,00	A	COMMODORE VN - VP		>88<93			36	15
ODO-1960-HL946	76,00	A	COMMODORE VR - VS		>93	X		36	15
ODO-1960-TO295	76,00	A	NOVA			X		33	15,25
HONDA									
ODO-1960-HO2822	76,00	A	ACCORD		>84<08/89			29	14
ODO-1960-HO2823	76,00	A			>90<92	X		29	14
ODO-1960-HO900	76,00	A			>93<95	X		29	14
ODO-1960-HO189	76,00	A			>96	X		33	15,25
ODO-1960-HO2822	76,00	A	CITY		>84<86			29	14
ODO-1960-HO2822	76,00	A	BALLADE		>84<87			29	14
ODO-1960-HO285	86,00	A			>88<91	X		29	14
ODO-1960-HO56	72,00	A			>03/92<95	X		29	14
ODO-1960-HO2822	76,00	A	CIVIC		>84<87			29	14
ODO-1960-HO285	86,00	A			>88<91	X		29	14
ODO-1960-HO56	72,00	A			>03/92<95	X		29	14
ODO-1960-HO189	76,00	A			>96	X		33	15,25
ODO-1960-HO977	105,00	A		airbag	>07<12	X	X	33	15,25
ODO-1960-HO980	105,00	A		airbag	>12<17	X	X	63	21
ODO-1960-HO772A	95,00	A	CIVIC - VTI	airbag	>02<05	X	X	33	15,25

R Ref	Euro		Car	Airbag	Year	Collap.	A. Alarm	N° Splines	Diam.
ODO-1960-HO285	86,00	A	CONCERTO		>88	x		29	14
ODO-1960-HO772A	95,00	A	CRV	airbag	>02<05	X	X	33	15,25
ODO-1960-HO977	105,00	A		airbag	>07<12	X	X	33	15,25
ODO-1960-HO980	105,00	A		airbag	>12<17	X	X	63	21
ODO-1960-HO2822	76,00	A	CRX		>84<87			29	14
ODO-1960-HO285	86,00	A			>88<91	X		29	14
ODO-1960-HO56	72,00	A			>03/92<95	X		29	14
ODO-1960-HO285	86,00	A	INTEGRA (ACURA)		>86	X		29	14
ODO-1960-HO2822	76,00	A	JAZZ		>84<86			29	14
ODO-1960-HO285	86,00	A	LEGEND (ACURA)		>86<92	X		29	14
ODO-1960-HO2822	76,00	A	PRELUDE		>84<03/92			29	14
ODO-1960-HO287	76,00	A			>04/92	X		29	14
ODO-1960-HO772A	95,00	A	S 2000	airbag	>00<04	X	X	33	15,25
ODO-1960-HO2822	76,00	A	SHUTTLE		>84<87			29	14
ODO-1960-HO285	86,00	A			>88<95	X		29	14
ODO-1960-HO2822	76,00	A	TODAY		>84			29	14
ODO-1960-HO2822	76,00	A	VIGOR		>84<08/89			29	14
ODO-1960-HO2823	76,00	A			>90<92	X		29	14
ODO-1960-HO900	76,00	A			>93<95	X		29	14
HYUNDAI									
ODO-1960-MI910	76,00	A	ACCENT		>94<96	X		36	14,9
ODO-1960-HY2853	86,00	A			>97	X		36	14,9
ODO-1960-HY85	86,00	A	GALLOPER		>98	X		36	14,9
ODO-1960-HY970	105,00	A	I 10	airbag	>13	X	X	34	14,8
ODO-1960-HY970	105,00	A	I 20	airbag	>13	X	X	34	14,8
ODO-1960-HY85	86,00	A	LANTRA EXCEL		>91<93	X		36	14,9
ODO-1960-MI276	76,00	A			>94			36	14,9
ODO-1960-HY85	86,00	A	PONY		>91	X		36	14,9
ODO-1960-HY85	86,00	A	S COUPE'		>91<96	X		36	14,9
ODO-1960-HY2851	76,00	A	SONATA		>89	X		36	14,9
ODO-1960-MI910	76,00	A	SONATA II			X		36	14,9
ODO-1960-HY2851	76,00	A	SONICA		>09/93<02/94	X		36	14,9
INNOCENTI									
ODO-1960-FI10	72,00	A	1000			X		37	16,5
ODO-1960-FI10	72,00	A	ELBA			X		37	16,5
ODO-1960-YU508	86,00	A	KORAL 45 - 55 - 60 - 65					20	16,25
ISUZU									
ODO-1960-IZ864	76,00	A	AMIGO - BELLET					28	13,85
ODO-1960-IZ864	76,00	A	IMPULSE - IMPULSE TURBO		>88			28	13,85
ODO-1960-IZ865	86,00	A	MONTEREY		>92			28	13,85
ODO-1960-IZ864	76,00	A	PICK-UP TRUCK					28	13,85
ODO-1960-IZ865	86,00	A	RODEO					28	13,85
JAGUAR									
ODO-1960-JA856	86,00	A	ALL MODELS		>68<75			48	21,4
ODO-1960-JA857	76,00	A	XJ12		>76			48	18,2
ODO-1960-JA857	76,00	A	XJ6		>76<86			48	18,2
ODO-1960-JA955	95,00	A	XJ8	airbag	>98<02	X	X	86	25,25
ODO-1960-JA857	76,00	A	XJS		>76<89			48	18,2
JEEP									
ODO-1960-CO810	92,00	A	CHEROKEE 1st series			X		36	16,5
ODO-1960-JE874	82,00	A	CHEROKEE 2nd series		>84<96			36	16,5
ODO-1960-JE978	105,00	A	CHEROKEE 3rd series		>96<01	X		33	16,5
ODO-1960-CO810	92,00	A	CJ3 - CJ5 - CJ6 - CJ7			X		36	16,5
ODO-1960-JE978	105,00	A	CJ7		>96<01	X		33	16,5
ODO-1960-CO810	92,00	A	PICK UP 1st series			X		36	16,5
ODO-1960-CO810	92,00	A	RENEGADE			X		36	16,5
ODO-1960-CO810	92,00	A	W. QUADRA TRAK			X		36	16,5
ODO-1960-CO810	92,00	A	WAGONER 1st series			X		36	16,5
ODO-1960-JE874	82,00	A	WRANGLER		>88			36	16,5
ODO-1960-JE978	105,00	A	WRANGLER TJ		>97<07	X		33	16,5
KIA									
ODO-1960-MA215	86,00	A	CAPITAL		>96	X		36	15
ODO-1960-MA215	86,00	A	CONCORD		>96	X		36	15
ODO-1960-MA215	86,00	A	PRIDE		>96	X		36	15
ODO-1960-MA215	86,00	A	SEPHIA		>94	X		36	15
ODO-1960-MA215	86,00	A	SPORTAGE		>94	X		36	15
LADA (SHIGULI)									
ODO-1960-LD880	76,00	A	110 - 111		>98			36	16,5
ODO-1960-LD820	76,00	A	SAMARA		>87			36	16,5
LANCIA									
ODO-1960-FI20	76,00	A	DEDRA		>89	X		37	16,5
ODO-1960-LA835	76,00	A	DELTA		>79<84			20	16,25
ODO-1960-LA837	76,00	A			>85<92			37	16,5
ODO-1960-LA58	76,00	A			>05/89			37	16,5

R Ref	Euro		Car	Airbag	Year	Collap.	A. Alarm	N° Splines	Diam.
OD0-1960-FI20	76.00	A			>93	X		37	16,5
OD0-1960-LA58	76.00	A	DELTA INTEGRALE		>05/89			37	16,5
OD0-1960-FI25	96.00	A	LYBRA			X		37	16,5
OD0-1960-LA58	76.00	A	LX		>05/89			37	16,5
OD0-1960-FI769A	95.00	A	MUSA	airbag	>04	X	X	37	16,5
OD0-1960-LA836	76.00	A	THEMA		>10/84<91			37	16,5
OD0-1960-FI10	72.00	A	THEMA LX		>92<02/93	X		37	16,5
OD0-1960-FI25	96.00	A	Y 1st series		>96<03	X		37	16,5
OD0-1960-FI769A	95.00	A	Y 2nd series	airbag	>03<16	X	X	37	16,5
OD0-1960-CI944	76.00	A	Z		>10/94	X		40	16,7
LAND ROVER									
OD0-1960-RO803	86.00	A	DEFENDER		>09/88<91	X		36	16,5
OD0-1960-RO934	76.00	A			>92<95	X		48	18,2
OD0-1960-RO888	76.00	A			>96<98			48	18,2
OD0-1960-RO803	86.00	A			>99	X		36	16,5
OD0-1960-RO966	86.00	A			>12	X		48	18,2
OD0-1960-RO938	76.00	A	DISCOVERY		>90<96	X		36	16,5
OD0-1960-RO939	86.00	A			>94<98	X		29	14
OD0-1960-RO803	86.00	A			>98<01	X		36	16,5
OD0-1960-RO960	95.00	A	DISCOVERY 2nd series	airbag	>98<04	X	X	29	14
OD0-1960-RO959	95.00	A	FREELANDER	airbag	>96	X	X	29	14
OD0-1960-RO803	86.00	A	LAND ROVER 90/110		>09/88<92	X		36	16,5
OD0-1960-RO934	76.00	A			>92<96	X		48	18,2
OD0-1960-RO933	76.00	A	RANGE ROVER		>83<86	X		36	16,5
OD0-1960-RO936	76.00	A			>87<94	X		36	16,5
LOTUS									
OD0-1960-LO877	76.00	A	ELAN - ELAN 2+2 EUROPA					36	15
OD0-1960-LO879	86.00	A	ELAN		>88			28	13,85
OD0-1960-OP72	86.00	A	ELISE		>96<01	X		36	15
OD0-1960-LO878	76.00	A	ESPRITE		>80<87			36	15
OD0-1960-LO879	86.00	A			>88			28	13,85
OD0-1960-LO877	76.00	A	SUPER 7					36	15
MASERATI									
OD0-1960-MS869	76.00	A	4 PORTE		>80			36	16,5
OD0-1960-MS869	76.00	A	BI TURBO		>80			36	16,5
OD0-1960-MS869	76.00	A	KARIF					36	16,5
OD0-1960-MS869	76.00	A	MERAK		>80			36	16,5
OD0-1960-CH925	76.00	A	TC			X		36	16,5
MAZDA									
OD0-1960-MA215	86.00	A	121		>91<95	X		36	15
OD0-1960-FO36-2	86.00	A			>96<96	X		HEXAGON	-
OD0-1960-FO541	95.00	A		airbag	>97	X	X	HEXAGON	-
OD0-1960-MA215	86.00	A	323		>81	X		36	15
OD0-1960-MA215	86.00	A	626 FRONT WD		>83<91	X		36	15
OD0-1960-MA218	72.00	A	626		>01/92	X		36	15
OD0-1960-MA215	86.00	A	929		>83	X		36	15
OD0-1960-MA215	86.00	A	COSMO		>83	X		36	15
OD0-1960-MA215	86.00	A	E 2000		>05/90	X		36	15
OD0-1960-MA218	72.00	A	EUNOS 500		>01/92	X		36	15
OD0-1960-MA215	86.00	A	FESTIVA			X		36	15
OD0-1960-MA215	86.00	A	FORD LASER 1300		>81	X		36	15
OD0-1960-FO542A	95.00	A	MAZDA 2	airbag	>02<07	X	X	HEXAGON	-
OD0-1960-MA215	86.00	A	MPV		>91	X		36	15
OD0-1960-MA215	86.00	A	MX-3		>91	X		36	15
OD0-1960-MA215	86.00	A	MX-5 - MIATA		>90	X		36	15
OD0-1960-MA215	86.00	A	MX-6		>91	X		36	15
OD0-1960-MA218	72.00	A			>01/92	X		36	15
OD0-1960-MA215	86.00	A	RX4		>83	X		36	15
OD0-1960-MA215	86.00	A	RX-7		>81	X		36	15
OD0-1960-MA218	72.00	A	XEDOS		>03/92	X		36	15
MERCEDES									
OD0-1960-ME906	105.00	A	BENZ./PUNCH		>83	X		66	20,7
OD0-1960-ME954	95.00	A	CLASS A - C - E - M - S - V	airbag		X	X	66	20,7
OD0-1960-ME906	105.00	A	R 129		>89	X		66	20,7
OD0-1960-ME855	105.00	A	VITO		>96			66	20,7
OD0-1960-ME906	105.00	A	W 107		>77<83	X		66	20,7
OD0-1960-ME906	105.00	A	W 123		>77<83	X		66	20,7
OD0-1960-ME906	105.00	A	W 124		>86<95	X		66	20,7
OD0-1960-ME906	105.00	A	W 126		>81<92	X		66	20,7
OD0-1960-ME906	105.00	A	W 140		>91	X		66	20,7
OD0-1960-ME906	105.00	A	W 201		>12/82<93	X		66	20,7
MG									
OD0-1960-MG861	86.00	A	MGB		>77			36	16,5
OD0-1960-MG861	86.00	A	MIDGET		>74			36	16,5

R Ref	Euro		Car	Airbag	Year	Collap.	A. Alarm	N° Splines	Diam.
MINI (BMW)									
OD0-1960-IN43	76,00	A	MINI COOPER		>91			48	18,2
OD0-1960-BM784A	95,00	A	MINI COOPER - ONE - R50 - R52 - R53	airbag	>02<07	X	X	60	20,5
OD0-1960-BM963	105,00	A	MINI COOPER - R55 - R56 - R57	airbag	>07<13	X	X	60	20,5
MINI (INNOCENTI)									
OD0-1960-IN43	76,00	A	3 cilindri		>82			48	18,2
OD0-1960-IN43	76,00	A	90 - 120		>83			48	18,2
OD0-1960-IN43	76,00	A	990		>86			48	18,2
OD0-1960-IN43	76,00	A	DE TOMMASO		>83			48	18,2
OD0-1960-IN833	82,00	A	MINI 1000 - 1001		<82			48	18,2
OD0-1960-IN833	82,00	A	MINI COOPER 1300		>59<82			48	18,2
OD0-1960-IN833	82,00	A	MINI EXPORT		<82			48	18,2
OD0-1960-IN833	82,00	A	MINI MATIC		>59<82			48	18,2
MINI (ROVER)									
OD0-1960-IN43	76,00	A	MAYFAIR - COOPER		>09/91			48	18,2
MITSUBISHI									
OD0-1960-MI290	86,00	A	CARISMA		>95	X		36	14,9
OD0-1960-MI910	76,00	A	COLT		>84<88	X		36	14,9
OD0-1960-MI279	82,00	A			>92<96	X		36	14,9
OD0-1960-MI290	86,00	A			>98	X		36	14,9
OD0-1960-MI785A	105,00	A	COLT CZ3	airbag	>06	X	X	36	14,9
OD0-1960-MI910	76,00	A	CORDIA		>83<89	X		36	14,9
OD0-1960-MI276	76,00	A	ECLIPSE		>92			36	14,9
OD0-1960-MI910	76,00	A	ETERNA		>81<87	X		36	14,9
OD0-1960-MI276	76,00	A			>88<92			36	14,9
OD0-1960-MI290	86,00	A			>93	X		36	14,9
OD0-1960-MI910	76,00	A	IORE		>84<88	X		36	14,9
OD0-1960-MI279	82,00	A			>92<96	X		36	14,9
OD0-1960-MI910	76,00	A	GALANT		>81<87	X		36	14,9
OD0-1960-MI276	76,00	A			>88<92			36	14,9
OD0-1960-MI290	86,00	A			>93	X		36	14,9
OD0-1960-MI910	76,00	A	LANCER		>84<88	X		36	14,9
OD0-1960-MI910	76,00	A	LAMBDA		>81<87	X		36	14,9
OD0-1960-MI276	76,00	A			>88<92			36	14,9
OD0-1960-MI290	86,00	A			>93	X		36	14,9
OD0-1960-MI907	86,00	A	L200 - L300		>86<96	X		36	14,9
OD0-1960-MI279	82,00	A	LANCER		>92<96	X		36	14,9
OD0-1960-MI290	86,00	A	LANCER (central screw)		>97	X		36	14,9
OD0-1960-MI280A	96,00	A	LANCER EVO 8 (central screw)	airbag	>04<06	X	X	36	14,9
OD0-1960-MI910	76,00	A	MIRAGE		>84<88	X		36	14,9
OD0-1960-MI279	82,00	A			>92<96	X		36	14,9
OD0-1960-MI290	86,00	A			>98	X		36	14,9
OD0-1960-MI859	86,00	A	PAJERO (MONTERO)		<06/87			36	14,9
OD0-1960-MI288	86,00	A			>07/87<07/91	X		36	14,9
OD0-1960-MI907	86,00	A			>08/91	X		36	14,9
OD0-1960-MI910	76,00	A	SAPORO		>81	X		36	14,9
OD0-1960-MI276	76,00	A	SIGMA		>91			36	14,9
OD0-1960-MI908	86,00	A	SPACE GEAR		>95	X		36	14,9
OD0-1960-MI279	82,00	A	SPACE RUNNER		>92	X		36	14,9
OD0-1960-MI910	76,00	A	SPACE WAGON		>83<91	X		36	14,9
OD0-1960-MI279	82,00	A			>92	X		36	14,9
OD0-1960-MI910	76,00	A	STARION		>82	X		36	14,9
OD0-1960-MI910	76,00	A	TREDIA		>83<89	X		36	14,9
NISSAN									
OD0-1960-NI310	76,00	A	100 NX		>82<92	X		34	14,55
OD0-1960-NI315	76,00	A			>93<95	X		34	14,55
OD0-1960-NI310	76,00	A	200 SX		>89	X		34	14,55
OD0-1960-NI315	76,00	A			>93<02	X		34	14,55
OD0-1960-NI313	86,00	A	240 SX CC.			X		34	14,55
OD0-1960-NI310	76,00	A	300 ZX			X		34	14,55
OD0-1960-NI313	86,00	A	300 ZX CC. - 300 ZX TWIN TURBO CC.		>90	X		34	14,55
OD0-1960-NI972	135,00	A	350 Z	airbag	>03<09	X	X	33	15,25
OD0-1960-NI773	76,00	A	ALMERA		>96	X		34	14,55
OD0-1960-NI307	86,00	A	AUSTER		>82			36	16,5
OD0-1960-NI310	76,00	A	AXXES		>89	X		34	14,55
OD0-1960-NI307	86,00	A	BLUEBIRD MAXIMA		>82<85			36	16,5
OD0-1960-NI310	76,00	A			>86<88	X		34	14,55
OD0-1960-NI310	76,00	A	CHERRY		>83	X		34	14,55
OD0-1960-NI310	76,00	A	E4			X		34	14,55
OD0-1960-NI310	76,00	A	KING CAB		>84<96	X		34	14,55
OD0-1960-NI920	76,00	A			>97	X		34	14,55
OD0-1960-NI310	76,00	A	LANCLEY		>83	X		34	14,55
OD0-1960-NI310	76,00	A	LAUREL		>82	X		34	14,55
OD0-1960-NI307	86,00	A	LAUREL C 130					36	16,5

R	Ref	Euro	Car	Airbag	Year	Collap.	A. Alarm	N° Splines	Diam.
	ODO-1960-NI310	76,00	A	LIBERTA'	>83	X		34	14,55
	ODO-1960-NI313	86,00	A	MAXIMA C.C.		X		34	14,55
	ODO-1960-NI310	76,00	A	MICRA - MARCH	>82<84	X		34	14,55
	ODO-1960-NI964	82,00	A		>85<91	X		34	14,55
	ODO-1960-NI314	76,00	A		>92<95	X		34	14,55
	ODO-1960-NI773	76,00	A	MICRA	>96	X		34	14,55
	ODO-1960-NI781A	95,00	A		airbag >03	X	X	33	16,4
	ODO-1960-NI310	76,00	A	PATHFINDER	>87<92	X		34	14,55
	ODO-1960-NI315	76,00	A		>93<02	X		34	14,55
	ODO-1960-NI307	86,00	A	PATROL	>82			36	16,5
	ODO-1960-NI310	76,00	A	PATROL GR - TR	>89<93	X		34	14,55
	ODO-1960-NI310	76,00	A	PICK UP	>98	X		34	14,55
	ODO-1960-NI920	76,00	A		>99	X		34	14,55
	ODO-1960-NI310	76,00	A	PRAIRIE	>82	X		34	14,55
	ODO-1960-NI314	76,00	A	PRIMERA	>90<92	X		34	14,55
	ODO-1960-NI315	76,00	A		>93	X		34	14,55
	ODO-1960-NI313	86,00	A	PULSAR C.C. - PULSAR EXA C.C.		X		34	14,55
	ODO-1960-NI310	76,00	A	PULSAR	>83	X		34	14,55
	ODO-1960-NI310	76,00	A	ROADSTER 1600 - 2000		X		34	14,55
	ODO-1960-NI310	76,00	A	SAFARI	>89<93	X		34	14,55
	ODO-1960-NI310	76,00	A	SENTRA	>82	X		34	14,55
	ODO-1960-NI920	76,00	A		>96	X		34	14,55
	ODO-1960-NI314	76,00	A	SERENA	>93	X		34	14,55
	ODO-1960-NI921	76,00	A		>98	X		34	14,55
	ODO-1960-NI310	76,00	A	SILVIA	>84<89	X		34	14,55
	ODO-1960-NI971	105,00	A	SILVIA SX	airbag >98<02	X	X	33	15,25
	ODO-1960-NI307	86,00	A	SKYLINE (C. 110 G.C. 110)				36	16,5
	ODO-1960-NI310	76,00	A	SPIRIT	>82	X		34	14,55
	ODO-1960-NI310	76,00	A	SS50	>82	X		34	14,55
	ODO-1960-NI307	86,00	A	STANZA	>82			36	16,5
	ODO-1960-NI310	76,00	A	SUNNY	>82<92	X		34	14,55
	ODO-1960-NI315	76,00	A		>93<95	X		34	14,55
	ODO-1960-NI310	76,00	A	TERRANO	>87<92	X		34	14,55
	ODO-1960-NI315	76,00	A		>93<02	X		34	14,55
	ODO-1960-NI920	76,00	A	TERRANO II	>96	X		34	14,55
	ODO-1960-NI310	76,00	A	URVAN		X		34	14,55
	ODO-1960-NI307	86,00	A	VANNETTE	<97			36	16,5
	ODO-1960-NI920	76,00	A		>98	X		34	14,55
	ODO-1960-NI310	76,00	A	VILLA	>82	X		34	14,55
	ODO-1960-NI307	86,00	A	VIOLET	>82			36	16,5
OPEL									
	ODO-1960-OP72	86,00	A	ASCONA C	>10/81<89	X		36	15
	ODO-1960-OP72	86,00	A	ASTRA	>91	X		36	15
	ODO-1960-OP779A	105,00	A	ASTRA F	airbag >96	X	X	36	15
	ODO-1960-OP580A	95,00	A	ASTRA G	airbag >98	X	X	66	20,7
	ODO-1960-OP72	86,00	A	CALIBRA	>90<96	X		36	15
	ODO-1960-OP779A	105,00	A		airbag >96	X	X	36	15
	ODO-1960-OP72	86,00	A	CORSA A	>82<93	X		36	15
	ODO-1960-OP72	86,00	A	CORSA B	>94<97	X		36	15
	ODO-1960-OP779A	105,00	A		airbag >97<00	X	X	36	15
	ODO-1960-OP581A	95,00	A	CORSA B (EPS)	airbag >98	X	X	34	14,8
	ODO-1960-OP580A	95,00	A	CORSA C	airbag >01<06	X	X	66	20,7
	ODO-1960-OP817	105,00	A	CORSA D	airbag >06	X	X	60	20,5
	ODO-1960-IZ865	86,00	A	FRONTERA	>91			28	13,85
	ODO-1960-OP72	86,00	A	KADETT D-E	>79<91	X		36	15
	ODO-1960-IZ865	86,00	A	MONTREY	>92			28	13,85
	ODO-1960-OP72	86,00	A	OMEGA	>86<90	X		36	15
	ODO-1960-OP779A	105,00	A	OMEGA B	airbag >90<03	X	X	36	15
	ODO-1960-OP72	86,00	A	SENATOR	>88<94	X		36	15
	ODO-1960-OP72	86,00	A	TIGRA	>94	X		36	15
	ODO-1960-OP779A	105,00	A	TIGRA A	airbag >97<98	X	X	36	15
	ODO-1960-OP72	86,00	A	VECTRA	>89<95	X		36	15
	ODO-1960-OP779A	105,00	A	VECTRA A-B	airbag >95<02	X	X	36	15
	ODO-1960-OP779A	105,00	A	VITA	airbag >95<02	X	X	36	15
	ODO-1960-OP580A	95,00	A	ZAFIRA	airbag >98	X	X	66	20,7
PEUGEOT									
	ODO-1960-PE85	76,00	A	104 ECO / ZS/ ZL	>80<89	X		40	16,7
	ODO-1960-PE190	86,00	A	106	>09/91	X		40	16,7
	ODO-1960-CI143A	105,00	A		airbag >96	X	X	40	16,7
	ODO-1960-CI786A	95,00	A	107	airbag >06	X	X	33	15,25
	ODO-1960-PE973	105,00	A	108	airbag >14	X	X	33	16,4
	ODO-1960-PE85	76,00	A	205	>83<06/87	X		40	16,7
	ODO-1960-PE89C	76,00	A		>07/87	X		40	16,7
	ODO-1960-PE193A	95,00	A	206	airbag >98	X	X	40	16,7

R Ref	Euro		Car	Airbag	Year	Collap.	A. Alarm	N° Splines	Diam.
OD0-1960-PE782A	95,00	A	206 - 206 CC	airbag	>03	X	X	33	16,4
OD0-1960-PE782A	95,00	A	207	airbag	>06	X	X	33	16,4
OD0-1960-PE974	105,00	A	208	airbag	>12	X	X	33	16,4
OD0-1960-PE190	86,00	A	306		>03/93	X		40	16,7
OD0-1960-PE782A	95,00	A	307	airbag	>03	X	X	33	16,4
OD0-1960-PE95A	86,00	A	308	airbag	>07	X	X	33	14,4
OD0-1960-PE87	76,00	A	309		>86<05/89			40	16,7
OD0-1960-PE87-1	76,00	A			>06/89<93	X		40	16,7
OD0-1960-PE89-1	76,00	A	405		>07/87<06/92	X		40	16,7
OD0-1960-PE91-2	76,00	A			>07/92<95	X		40	16,7
OD0-1960-PE91-2	76,00	A	406		>95	X		40	16,7
OD0-1960-CI944	76,00	A	605		>90	X		40	16,7
OD0-1960-CI944	76,00	A	806		>10/94	X		40	16,7
OD0-1960-CI141	95,00	A	PARTNER - RANCH		>97	X		40	16,7
PORSCHE									
ALL MODELS									
OD0-1960-PO839	76,00	A			<73			40	20
OD0-1960-PO92	76,00	A	911 included Targa/Carrera		>74<88			40	20
OD0-1960-PO841	82,00	A	911S - 912S - 928 - CARRERA		<93			40	20
OD0-1960-PO92	76,00	A	912 America Model*		>65<70			40	20
OD0-1960-PO885	82,00	A	924 - TURBO		>76<84			40	16,7
OD0-1960-PO92	76,00	A	928 - 928 S		<08/95			40	20
OD0-1960-PO92	76,00	A	928 - 928 S4		>09/95			40	20
OD0-1960-PO885	82,00	A	944		>76<84			40	16,7
OD0-1960-VW145	86,00	A			>82<84	X		40	16,7
OD0-1960-PO806	76,00	A			>85			40	16,7
OD0-1960-PO967	95,00	A	981 GT4 CS	airbag	>15	X	X	86	25,25
OD0-1960-PO806	76,00	A	996		<96			40	16,7
OD0-1960-VW239A	95,00	A	997	airbag	>04	X	X	86	25,25
OD0-1960-PO961	95,00	A	BOXSTER	airbag	>96	X	X	40	16,7
OD0-1960-PO806	76,00	A	CARRERA 2 - 4 - RS		>89<93			40	16,7
OD0-1960-VW239A	95,00	A	CAYMAN	airbag	>04	X	X	86	25,25
OD0-1960-PO840	76,00	A	VW PORSCHE 914 (4 Cyl.)		>72			40	20
RENAULT									
OD0-1960-RE108	76,00	A	CHAMADE		>04/89	X		40	16,7
OD0-1960-RE107C	76,00	A	CLIO 1st series		>90<98	X		40	16,7
OD0-1960-RE113	86,00	A	CLIO 2nd series		>98<05	X		33	16,4
OD0-1960-RE114A	95,00	A	CLIO 3rd series	airbag	>05	X	X	33	16,4
OD0-1960-RE787A	102,00	A	CLIO RS	airbag	>06<08	X	X	33	16,4
OD0-1960-RE117A	95,00	A		airbag	>08	X	X	33	16,4
OD0-1960-RE883	76,00	A	ESPACE		>83<90			40	16,7
OD0-1960-RE108	76,00	A			>91	X		40	16,7
OD0-1960-RE106	76,00	A	EXPRESS					40	16,7
OD0-1960-RE884	76,00	A	KANGOO		>97			40	16,7
OD0-1960-RE896	82,00	A	LAGUNA		>94	X		40	16,7
OD0-1960-RE774A	105,00	A		airbag	>98	X	X	33	16,4
OD0-1960-RE112	76,00	A	MEGANE		>96			40	16,7
OD0-1960-RE774A	105,00	A	MEGANE SCENIC	airbag	>97	X	X	33	16,4
OD0-1960-RE108	76,00	A	R4 Safari			X		40	16,7
OD0-1960-RE106	76,00	A	R5		>11/84<90			40	16,7
OD0-1960-RE108	76,00	A	R 19		>89	X		40	16,7
OD0-1960-RE108	76,00	A	R 21		>86<95	X		40	16,7
OD0-1960-RE895	76,00	A	SAFRANE		>93	X		40	16,7
OD0-1960-RE117A	95,00	A	SCENIC II	airbag	>03	X	X	33	16,4
OD0-1960-RE106	76,00	A	SUPER 5		>11/84<90			40	16,7
OD0-1960-RE107C	76,00	A	TWINGO		>93<97	X		40	16,7
OD0-1960-RE113	86,00	A			>97<98	X		33	16,4
OD0-1960-RE775A	84,00	A		airbag	>98	X	X	33	16,4
ROVER									
OD0-1960-RO875	76,00	A	111 - 114		>90<95			48	18,2
OD0-1960-HO2822	76,00	A	416 GT		>91			29	14
OD0-1960-RO875	76,00	A	SERIES 100		>90			48	18,2
OD0-1960-HO285	86,00	A	SERIES 200		>90	X		29	14
OD0-1960-HO285	86,00	A	SERIES 400		>90	X		29	14
OD0-1960-HO56	72,00	A	SERIES 600		>11/93	X		29	14
OD0-1960-RO935	76,00	A	SERIES 800		>92<96	X		29	14
SAAB									
OD0-1960-OP580A	95,00	A	9-3	airbag	>02	X	X	66	20,7
OD0-1960-SA848	82,00	A	99		>70			36	15
OD0-1960-SA848	82,00	A	900		>70			36	15
OD0-1960-SA850	82,00	A	900 APC SYSTEM		>82<95			36	15
OD0-1960-SA850	82,00	A	9000		>82<95			36	15
OD0-1960-SA848	82,00	A	TURBO 900		>70			36	15
OD0-1960-SA849	76,00	A			>82			36	15
SEAT									

STEERING WHEEL HUBS - USA

Application List

R Ref	Euro	Car	Airbag	Year	Collap.	A. Alarm	N° Splines	Diam.
AVANTI								
OD0-1960-CO810	92,00	A	ALL MODELS		X		36	16,5
BUICK								
OD0-1960-CO810	92,00	A	ALL MODELS	>69	X		36	16,5
CADILLAC								
OD0-1960-CO810	92,00	A	ALL MODELS	>69	X		36	16,5
CHEVROLET								
OD0-1960-CO810	92,00	A	ALL MODELS	>69	X		36	16,5
OD0-1960-CO810	92,00	A	ASTRO (all models)		X		36	16,5
OD0-1960-CO810	92,00	A	BERETTA	>88	X		36	16,5
OD0-1960-JE874	82,00	A	BLAZER	<92	X		36	16,5
OD0-1960-JE874	82,00	A	BLAZER S 10	<92	X		36	16,5
OD0-1960-JE874	82,00	A	C/K PICK-UP	<92	X		36	16,5
OD0-1960-CO810	92,00	A	CAMARO	>69	X		36	16,5
OD0-1960-CO810	92,00	A	CAVALIER		X		36	16,5
OD0-1960-CO810	92,00	A	CELEBRITY		X		36	16,5
OD0-1960-CO810	92,00	A	CHEVELLE	>74	X		36	16,5
OD0-1960-CO810	92,00	A	CORVETTE	>69<83	X		36	16,5
OD0-1960-CO810	92,00	A	IMPALA	>74	X		36	16,5
OD0-1960-TO299	76,00	A	NOVA	>85	X		33	15,25
OD0-1960-CH871	76,00	A	SPRINT	>08/86	X		30	13,4
OD0-1960-CO810	92,00	A	SUBURBAN	<87	X		36	16,5
OD0-1960-JE874	82,00	A		>88<92	X		36	16,5
CHRYSLER								
OD0-1960-CH925	76,00	A	CARAVAN - VOYAGER	>88	X		36	16,5
OD0-1960-MI910	76,00	A	CONQUEST	>83	X		36	14,9
OD0-1960-CH925	76,00	A	LASER	>84	X		36	16,5
OD0-1960-CH925	76,00	A	LEBARON GTS - CONVERT.	>85	X		36	16,5
OD0-1960-CH925	76,00	A	NEW YORKER - FWD	>84	X		36	16,5
OD0-1960-CH925	76,00	A	SARATOGA	>10/91	X		36	16,5
DOGDE								
OD0-1960-CH925	76,00	A	CARAVAN	>88	X		36	16,5
OD0-1960-MI910	76,00	A	CHALLENGER	>76	X		36	14,9
OD0-1960-MI910	76,00	A	COLT	<84	X		36	14,9
OD0-1960-MI910	76,00	A	COLT - GLI - TURBO	>85	X		36	14,9
OD0-1960-MI910	76,00	A	CONQUEST		X		36	14,9
OD0-1960-CH925	76,00	A	DAYTONA - DAYTONA TURBO	>84	X		36	16,5
OD0-1960-CH925	76,00	A	LANCER	>85	X		36	16,5
OD0-1960-RE108	76,00	A	MONACO	>90	X		40	16,7
OD0-1960-CH925	76,00	A	SHADOW - SHADOW ES	>85	X		36	16,5
OD0-1960-CH925	76,00	A	SHELBY DAYTONA	>84	X		36	16,5
OD0-1960-CH925	76,00	A	SHELBY SHADOW	>85	X		36	16,5
OD0-1960-CH925	76,00	A	SPIRIT - SPIRIT ES	>08/88	X		36	16,5
OD0-1960-MI276	76,00	A	STEALTH		X		36	14,9
EAGLE								
OD0-1960-RE108	76,00	A	PREMIER		X		40	16,7
OD0-1960-MI910	76,00	A	SUMMIT		X		36	14,9
OD0-1960-MI910	76,00	A	TALON		X		36	14,9
FORD AUSTRALIA								
OD0-1960-FO863	86,00	A	FALCON & FAIRLANE XR - XT - ZA - ZB	>66<68	X		40	16,7
OD0-1960-FO901	76,00	A	LASER	>05/86	X		36	15
OD0-1960-FO901	76,00	A	TELSTAR	>86	X		36	15
OD0-1960-FO924	76,00	A	ZC - ZD - ZE - ZF - XA - XW - XY	>69<72	X		40	16,7
OD0-1960-FO924	76,00	A	ZG - ZH - ZJ - XB - XC - XD	>73<81	X		40	16,7
FORD USA								
OD0-1960-FO924	76,00	A	ALL MODELS	>68<71	X		40	16,7
OD0-1960-FO863	86,00	A		>72<82	X		40	16,7
OD0-1960-FO924	76,00	A	BRONCO 4X4	>75<81	X		40	16,7
OD0-1960-FO901	76,00	A	CAPRI		X		36	15
OD0-1960-FO863	86,00	A	F.150 - F.250 - F.350	<91	X		40	16,7
OD0-1960-FO901	76,00	A	FESTIVA	>05/87	X		36	15
OD0-1960-FO862	86,00	A	MUSTANG	>67	X		40	16,7
OD0-1960-FO924	76,00	A		>69<73	X		40	16,7
OD0-1960-FO863	86,00	A		>79<82	X		40	16,7
OD0-1960-FO958	95,00	A	MUSTANG GT	airbag	X		HEXAGON	-
OD0-1960-FO862	86,00	A	PICK-UP	>69	X		40	16,7
OD0-1960-FO901	76,00	A	PROBE	>89<92	X		36	15
GEO								
OD0-1960-SU766	76,00	A	METRO	<09/91	X		30	13,4
OD0-1960-GE927	76,00	A		>10/91	X		30	13,4

Remark

N = New

NV = Variation

Years

> Major of

< Minor of

R Ref	Euro		Car	Airbag	Year	Collap.	A. Alarm	N° Splines	Diam.	
OD0-1960-TO299	76,00	A		PRISM			X	33	15,25	
OD0-1960-SU761	76,00	A		TRACKER			X	30	13,4	
GMC										
OD0-1960-CO810	92,00	A		JIMMY	<87		X	36	16,5	
OD0-1960-JE874	82,00	A			>88<92		X	36	16,5	
OD0-1960-CO810	92,00	A		YUKON	<87		X	36	16,5	
OD0-1960-JE874	82,00	A			>88<92		X	36	16,5	
OD0-1960-JE874	82,00	A		S15 - S15 JIMMY	<92		X	36	16,5	
OD0-1960-CO810	92,00	A		SUBURBAN	<87		X	36	16,5	
OD0-1960-JE874	82,00	A			>87<92		X	36	16,5	
OD0-1960-JE874	82,00	A		TYPHOON	<92		X	36	16,5	
INFINITI										
OD0-1960-NI314	76,00	A		G20 (NO CRUISE CONTROL)			X	34	14,55	
LINCOLN										
OD0-1960-FO863	86,00	A		CONTINENTAL (all models)			X	40	16,7	
MERCURY										
OD0-1960-FO863	86,00	A		ALL MODELS	>72<80		X	40	16,7	
OD0-1960-FO32	76,00	A		LN-7	<83		X	HEXAGON	-	
OD0-1960-FO901	76,00	A		TRACER	>88		X	36	15	
MERKUR										
OD0-1960-FO36	76,00	A		SCORPIO	>03/86		X	X	HEXAGON	-
OD0-1960-FO32-1	76,00	A		XR4TI	>85		X	X	HEXAGON	-
OLDS MOBILE										
OD0-1960-CO810	92,00	A		ALL MODELS	>69		X	36	16,5	
OD0-1960-JE874	82,00	A		BRAVADA	<92		X	36	16,5	
PLYMOUTH										
OD0-1960-CH925	76,00	A		ACCLAIM	>89		X	36	16,5	
OD0-1960-CH925	76,00	A		CARAVELLE			X	36	16,5	
OD0-1960-MI910	76,00	A		COLT	>85<88		X	36	14,9	
OD0-1960-MI907	86,00	A			>92		X	36	14,9	
OD0-1960-MI910	76,00	A		CONQUEST	>84		X	36	14,9	
OD0-1960-MI910	76,00	A		LASER	>89		X	36	14,9	
OD0-1960-CH925	76,00	A		VOYAGER	>88		X	36	16,5	
PONTIAC										
OD0-1960-CO810	92,00	A		ALL MODELS	>69		X	36	16,5	
OD0-1960-JE874	82,00	A		FIERO	>84		X	36	16,5	
OD0-1960-OP72	86,00	A		LE MANS	>88		X	36	15	
OD0-1960-CO810	92,00	A		TRANSPORT	>90		X	36	16,5	
STERLING										
OD0-1960-HO2822	76,00	A		ALL MODELS			X	29	14	
STUTZ										
OD0-1960-CO810	92,00	A		ALL MODELS			X	36	16,5	

Airbag Alarm = Hub equipped with shout down cable for instrument panel's light

Airbag = car with steering wheel equipped with airbag

* = Original steering wheel horn internals are required to be removed and fitted to the OMP hubs

STRUT BRACES

Application List

Art	Euro		Car	Version	Year	Feat.
UNIVERSAL						
	MA0-1747-A01	109,00	A	Universal	Lenght: 820/960 mm	P S * R
U.S.L.	MA0-1747-A02	133,00	A	Universal	Lenght: 820/960 mm	P S # R
U.S.L.	MA0-1847	183,00	A	Universal	Lenght: 980/1080 mm	P S * R
ALFA ROMEO						
	MA0-1738	121,00	A	33	4 Attack Grooves (NO Imola)	A S * R
U.S.L.	MA0-1764	163,00	A	145/146	1.6 IE Twin Spark	A S * R
	MA0-1752	153,00	A		2.0 16v Twin Spark	A S * R
	MA0-1858	157,00	A	147	1.6 TS - 2.0 Twin Spark	>10/00 A S * R
	MA0-1896	185,00	A		1.9 JTD 115 CV	>03 A S * R
	MA0-1733	161,00	A	155	1.7 IE - 1.8 IE - 2.0 Twin Spark 16v also with ABS	A S * R
	MA0-1783	158,00	A	156	2.0 16v Twin Spark	A S * R
	MA0-1785	115,00	A		2.0 16v Twin Spark	A I *
	MA0-1920	206,00	A	159	2.4 JTDm 20V	>05 A S * R
	MA0-1896	185,00	A	GT	1.9 JTD 16V	>03 A S * R
U.S.L.	MA0-1812	220,00	A	GTV	3.0 V6 24V	A S * R
	MA0-1927	121,00	A	MITO	1.6 16V JTDm 120CV	>08 A I *
	MA0-1927	121,00	A		1.4 Turbo with original engine protection (apron INE)	>06/08 A I *
AUDI						
	MA0-1782	153,00	A	A3	1.9 TDI	<03 A S *
	MA0-1788	120,00	A		All Models (no 1.9 130 TDI)	<03 A I *
	MA0-1930	181,00	A		8p all models excluded S3	>03 A S *
U.S.L.	MA0-1754	158,00	A	A4	1.8 20v - 1.9 TDI	<00 A S *
	MA0-1910	324,00	A	A5	3.0 TDI Quattro	A S # R
AUTOBIANCHI						
	MA0-1529	129,00	A	A112		A S * R
BMW						
U.S.L.	MA0-1931	197,00	A	Series 1 E87	120d	>05 A S #
	MA0-1557	271,00	A	Series 3 E30	316 - 318 - 323	<87 A S #
U.S.L.	MA0-1750	188,00	A	Series 3 E36	316i - 318i (Berlina, Coupè)	<96 A S *
	MA0-1742	231,00	A		320i - 325i - 328 - M3 (Berlina, Coupè)	A S # R
	MA0-1825	271,00	A	Series 3 E46	320	>98 A S # R
	MA0-1825	271,00	A		330D	>98 A S # R
	MA0-1884	164,00	A	Series 5 E39	M5	A S *
CHRYSLER						
U.S.L.	MA0-1773	156,00	A	NEON		>95<99 P S *
CITROEN						
U.S.L.	MA0-1633	151,00	A	AX 1st series	Sport	A S * R
	MA0-1685	159,00	A		1.4 GTI - GT 2 attack grooves	A S * R
	MA0-1635	119,00	A		All Models	A I *
	MA0-1904	188,00	A	C1	1	A S * R
	MA0-1880	125,00	A	C2	1.1 - 1.4 - 1.6	<08 A S *
	MA0-1880	125,00	A	C3	1.1 - 1.4 - 1.6	A S *
	MA0-1724	93,00	A	SAXO	1.4 - 1.6	A I *
	MA0-1771	152,00	A		1.6 VTS 8v	A S * R
	MA0-1781	136,00	A		1.6 VTS 16v	A S * R
	MA0-1787	168,00	A	XSARA	1.9 TD	A S * R
FIAT						
	MA0-1533	117,00	A	127	900	A S * R
	MA0-1912	159,00	A	500	1.3 MTJ/ 1.4 100 CV	>07 A S * R Z
	MA0-1912	159,00	A		ABARTH	>03/08 A S * R Z
	MA0-1915	94,00	A			>03/08 A I *
	MA0-1915	94,00	A		1.3 MTJ/ 1.4 100 CV	>07 A I *
	MA0-1770	145,00	A	BARCETTA	1.8 16v (without ABS)	A S * R
	MA0-1732	160,00	A	BRAVO/BRAVA	1.4 12v - 1.6 16v (without ABS)	>95<01 A S * R
	MA0-1740	125,00	A	CINQUECENTO	1.1 - 1.1 Sporting	A S * R
	MA0-1696	73,00	A		700 - 900 - 1.1 Sporting	A I *
	MA0-1732	160,00	A	COUPÈ	2.0 16v - 2.0 Turbo 16v	A S * R
U.S.L.	MA0-1902	204,00	A	GRANDE PUNTO	1.3 MTJ 90 CV	A S * R Z
	MA0-1878	94,00	A	PANDA	1,2	>03 A S * R
	MA0-1878	94,00	A		1.4 16V 100 HP	>06 A S * R

Art	Euro		Car	Version	Year	Feat.
MAO-1721	157,00	A	PUNTO 1st series	1.4 GT Turbo - 90 - 16v Sporting	<97	A S * R
U.S.L. MAO-1749	192,00	A		1.4 GT Turbo - 90 - 16v Sporting	<97	A S # R
U.S.L. MAO-1831	164,00	A	PUNTO 2nd series	Sporting 1.2 16v/ 1.8 HGT	>99	A I * 4 points
MAO-1823	157,00	A		Sport 1.2 16v/1.8 HGT no ABS	>99<03	A S * R
MAO-1835	161,00	A		1.9 JTD	>99<03	A S * R
MAO-1813	135,00	A	SEICENTO	1.1 Sporting	<02	A S * R
MAO-1879	151,00	A		1.1 - 1.1 Sporting	>02<06	A S * R
MAO-1696	73,00	A		700/ 900/1.1 Sporting		A I *
MAO-1852	164,00	A	STILO	1.6 16v - 1.9 JTD - 1.9 MJT 140 CV	>10/01	A S * R
U.S.L. MAO-1855	85,00	A		All Models		P S *
U.S.L. MAO-1669	188,00	A	TIPO	1.1 - 1.4 - 1.6 (model with carburettors)		A S * R
MAO-1609	157,00	A	UNO 1st and 2nd series	1.3 Turbo - 1.4 Turbo (without Antiskid)		A S * R
MAO-1542	71,00	A		All Models		P S *
FORD						
MAO-1608	145,00	A	ESCORT	XR3 injection - RS Turbo		A S *
U.S.L. MAO-1751	105,00	A		Cosworth		P S *
MAO-1630	74,00	A	FIESTA 2nd series	XR2	<89	P S *
MAO-1629	132,00	A		XR2	<89	A S *
MAO-1658	151,00	A	FIESTA 3rd series	XR2i - RS Turbo	>89<92	A S * R
MAO-1659	115,00	A		XR2i	>89	P S *
MAO-1761	131,00	A	FIESTA 4th series	1.2 16v	>95<10/01	A S *
MAO-1762	50,50	A		1.2 16v	>95	A I *
MAO-1763	85,00	A		1.2 16v	>95	P S *
MAO-1895	168,00	A	FIESTA 5th series	1.2 / ST 150 / 1.4 TDCI / 1.6 D/1.6 TDCI	>05/02	A S * R
MAO-1821	179,00	A	FOCUS	1.6 16v		A S * R
MAO-1867	179,00	A		1.9 TDCI	>10/01	A S * R
U.S.L. MAO-1868	115,00	A		1.9 TDCI	>10/01	A I *
MAO-1753	170,00	A	MONDEO	1.8 - 2.0 16v	<00	A S * R
MAO-1798	149,00	A	PUMA	1.7 16v		A S *
MAO-1762	50,50	A		1.7 16v		A I *
MAO-1763	85,00	A		1.7 16v		P S *
MAO-1660	155,00	A	SIERRA	Cosworth		A S *
U.S.L. MAO-1751	105,00	A		Cosworth		P S *
HONDA						
U.S.L. MAO-1648	71,00	A	CIVIC	1.6 16v	<91	P S *
MAO-1908	185,00	A	INTEGRA	Type-R Type-S/ 1.8i	>01/06	A S * R
MAO-1909	89,00	A		Type-R Type-S/ 1.8i	>01/06	P S *
U.S.L. MAO-1841	158,00	A	S 2000		>99	A S * R
U.S.L. MAO-1804	156,00	A	COUPÈ	S 2.0	>02	A S * R
U.S.L. MAO-1871	273,00	A		2	>02	A S # extruded long flanges
U.S.L. MAO-1885	86,00	A	S TYPE	4.2 8V R		P S *
LANCIA						
MAO-1638	181,00	A	DELTA 1st series	2.0 4WD - 2.0 4WD 8v (No ABS)		A S * R
MAO-1661	142,00	A		2.0 4WD 16v		A S * R
MAO-1680	109,00	A		2.0 4WD - 2.0 4WD 8v e 16v - 2.0 HF EVO		P S *
U.S.L. MAO-1664	149,00	A		2.0 4WD 16v - 2.0 HF EVO (2 arms for connection without tank)		P I *
MAO-1663	175,00	A		2.0 4WD - 2.0 4WD 8v e 16v - 2.0 HF EVO		P I *
MAZDA						
U.S.L. MAO-1882	183,00	A	3	1.6 16v	>04	A S #
U.S.L. MAO-1883	62,00	A		1.6 16v	>04	A I *
MAO-1845	175,00	A	MX-5	Miata	>98	A S * R
MINI						
MAO-1869	157,00	A	MINI	1.6 - Cooper - Cooper S - JCW 210 HP	>9/01	A S * R
MAO-1870	109,00	A		1.6 - Cooper	>9/01	A I *
MAO-1913	185,00	A		1.6 - Cooper - D	>07	A S * R
U.S.L. MAO-1806	256,00	A		EVO 5		A S # double adjustment
U.S.L. MAO-1805	94,00	A		EVO 5		A S *
U.S.L. MAO-1897	164,00	A	COLT	1.5 DI - D	>06/94	A S * R
NISSAN						
MAO-1741	134,00	A	MICRA 2nd series	1.0 16v - 1.3 16v	>92<03	A S * R
U.S.L. MAO-1875	175,00	A	MICRA 3rd series	1.4	>01/03	A S * R
U.S.L. MAO-1684	179,00	A	SUNNY	2.0 GTI-R4 WD		A S * R
OPEL						

Art	Euro		Car	Version	Year	Feat.
U.S.L. MA0-1534	119,00	A	ASCONA B	2.0 GSI 16v		A S *
MA0-1681	159,00	A	ASTRA F	1.8 I 16v - 2.0 GSI 16v		A S *
MA0-1683	117,00	A		All Models		P S *
U.S.L. MA0-1817	79,00	A	ASTRA G	1.8 16v		A I *
U.S.L. MA0-1819	164,00	A		1.8 16v		A S *
U.S.L. MA0-1918	201,00	A	ASTRA GTC	1.9 TDCI		A S *
MA0-1615	133,00	A	CORSA A	1.3 GT	<03/93	A S * R
MA0-1666	135,00	A		1.6 GSI 8v	<03/93	A S * R
MA0-1699	125,00	A	CORSA B	1.6 GSI 16v		A S * R
MA0-1726	79,00	A		All Models	>97	P S *
U.S.L. MA0-1739	133,00	A		1.4 16v	<97	A S * R
U.S.L. MA0-1894	192,00	A	CORSA C	1.0 12v	>10/00	A S * R
MA0-1905	183,00	A	CORSA D	1,2		A S * R
MA0-1602	133,00	A	KADETT E	1.8 GSI - 2.0 GSI - 1.3 GT		A S * R
MA0-1644	145,00	A		2.0 GSI 16v		A S *
MA0-1627	107,00	A		1.8 GSI - 2.0 GSI 8v - 2.0 GSI 16v		A I *
MA0-1626	71,00	A		All Models		P S *
U.S.L. MA0-1739	133,00	A	TIGRA	1.4/ 1.6 16v	>94<00	A S * R
U.S.L. MA0-1894	192,00	A		1.3 DCI Twin Top	>04	A S * R
PEUGEOT						
MA0-1685	159,00	A	106	1.4 XSi (2 attack grooves)		A S * R
MA0-1722	135,00	A		1.3 Rally - 1.4 XSi - 1.4 XS - 1.1 XT		A S * R
MA0-1724	93,00	A		1.3 Rally - 1.6 Rally 16V - 1.4 XSi		A I *
MA0-1771	152,00	A		1.6 Rally 8v - 1.4 XT - 1.4 Sport- 1.1		A S * R
MA0-1781	136,00	A		1.6 GTI 16V - 1.6 Rally 16v		A S * R
MA0-1904	188,00	A	107	1		A S * R
MA0-1642	125,00	A	205	1.3 Rally		A S * R
MA0-1625	87,00	A		1.6 GTI - 1.9 GTI - TD		A I *
MA0-1554	142,00	A		1.6 GTI - 1.9 GTI - TD		A S * R
U.S.L. MA0-1601	246,00	A		1.6 GTI - 1.9 GTI		A S #
MA0-1811	129,00	A	206	1.1 - 1.4 - 1.6 XS - 2.0 HDI		A S * R
U.S.L. MA0-1900	143,00	A		1.6 HDI		A S * R
MA0-1917	157,00	A	207	1.6 Turbo GTI	>09/07	A S * R
MA0-1919	200,00	A		1.6 Turbo GTI		A I * R
MA0-1729	93,00	A	306	S 2.0 16v		A I *
MA0-1756	159,00	A		1.4 - 1.6 - S 2.0 16v 152 HP - 2.0 XSi		A S * R
MA0-1791	152,00	A		1.9 TD		A S * R
MA0-1911	159,00	A	307	2.0 HDI		A S * R
MA0-1667	145,00	A	309	1.9 GTI 16v		A S * R
MA0-1623	135,00	A		1.9 GTI		A S * R
MA0-1668	93,00	A		1.9 GTI 16v		A I *
MA0-1809	139,00	A	406	HDI Turbo Diesel - Coupè 2.0 140 CV	>99	A S * R
PORSCHE						
U.S.L. MA0-1757	279,00	A	911	mod. 933 Carrera 4	>93<97	A S # R
RENAULT						
MA0-1672	102,00	A	CLIO 1st series	1.8 16V - 2.0 16v Williams		A S *
U.S.L. MA0-1670	134,00	A		1.2i - 1.4i	<96	A S *
U.S.L. MA0-1816	169,00	A	CLIO 2nd series	1.2 - 1.4 - 1.6 16v	>98<05	A S *
MA0-1836	164,00	A		RS 2000	>98<05	A S * R
MA0-1838	105,00	A		RS 2000	>98<05	P S *
U.S.L. MA0-1901	175,00	A	CLIO 3rd series	1.5 DCI	>10/05	A S * R
MA0-1938	245,00	A	CLIO 4th series	RS	>13	A S *
U.S.L. MA0-1937	181,00	A	Megane 4th series	Saloon 4 doors	>2016	A S *
MA0-1553	133,00	A	R11	Turbo		A S * R
MA0-1604	129,00	A	SUPER 5	GT Turbo		A S * R
ROVER						
MA0-1767	133,00	A	25	All Models	>01/00<05	A S * R
MA0-1767	133,00	A	214	All Models	>96<00	A S * R
MA0-1767	133,00	A	MG 160	All Models		A S * R
SEAT						
MA0-1693	135,00	A	IBIZA 2nd series	2.0 GTI 8V - 2.0 GTI 16v - 1.8 16v - TDI	>93<02	A S *
MA0-1558	67,00	A		2.0 GTI 8v	>93<02	A I *
MA0-1695	83,00	A		All Models	>93<02	P S *
MA0-1833	149,00	A	IBIZA 3rd series	1.9 TDI	>02<09	A S * R

Art	Euro		Car	Version	Year	Feat.
MA0-1864	105,00	A		1.9 TDI	>02<09	A I *
MA0-1782	153,00	A	LEON	TDI 1.9 - 1.8	>99<05	A S *
MA0-1788	120,00	A		All Models	>99<05	A I *
SKODA						
MA0-1782	153,00	A	OCTAVIA	1.9 TDI		A S *
SUBARU						
MA0-1743	138,00	A	IMPREZA	2.0 16v Turbo 4WD	<12/00	A S * R
U.S.L. MA0-1861	187,00	A		WRX 4WD	>12/00<02	A S *
U.S.L. MA0-1862	268,00	A		WRX 4WD	>12/00<02	A S # extruded/ R steel flange/
SUZUKI						
MA0-1673	135,00	A	SWIFT	1.3 GTI 16v	>90<01	A S *
MA0-1674	121,00	A		1.3 GTI 16v	>90<01	P S *
TOYOTA						
MA0-1904	188,00	A	AYGO	1		A S * R
U.S.L. MA0-1790	149,00	A	COROLLA	1.6 16v	<01	A S * R
MA0-1768	156,00	A	PASEO	1.5 16v		A S * R
MA0-1826	153,00	A	YARIS	1.0 - 1.3 - 1.5 T-Sport	>99<05	A S * R
MA0-1828	85,00	A		1.0 16v	>99<05	P S *
U.S.L. MA0-1923	168,00	A		1.0 2nd series/1.4 D-4D	>05	A S * R
VOLKSWAGEN						
MA0-1538	95,00	A	GOLF 1st series	All Models		A S *
MA0-1535	56,00	A		All Models		A I *
MA0-1542	71,00	A		All Models		P S *
MA0-1606	123,00	A	GOLF 2nd series	1.8 GTI - 1.6 D - 1.6 GTD		A S *
MA0-1558	67,00	A		All Models		A I *
MA0-1612	80,00	A		All Models		P S *
U.S.L. MA0-1559	151,00	A		All Models (4 attack grooves)		A I *
MA0-1678	117,00	A	GOLF 3rd series	2.0 GTI - 2.0 GTI 16v - VR6 - 1.6 flat filter - 1.9 TD/1.9 TDI		A S *
MA0-1558	67,00	A		1.8 - 2.0 GTI - 2.0 GTI 16v		A I *
MA0-1612	80,00	A		1.8 - 2.0 GTI - 2.0 GTI 16v		P S *
MA0-1782	153,00	A	GOLF 4th series	1.9 TDI - 1.8 20v (NO 4 Motion) - 1.6 gasoline		A S *
MA0-1788	120,00	A		All Models (no 1.9 130 TDI)		A I *
U.S.L. MA0-1906	214,00	A	GOLF 5th series	2.0 GTI 16V/ 1.4 GT 170 CV		A S * R Z
U.S.L. MA0-1907	206,00	A		1.9 TDI/2.0 TDi 140 CV		A S * R Z
MA0-1846	144,00	A	LUPO	1.6 GTI	>00	A S * R
MA0-1678	117,00	A	PASSAT 2nd series	1.8 Variant - Saloon	<00	A S *
U.S.L. MA0-1656	129,00	A	POLO 1st series	1.0 - 1.3 - Coupè	<81	A S *
U.S.L. MA0-1657	71,00	A		1.0 - 1.3 - Coupè	<81	P S *
U.S.L. MA0-1759	75,00	A	POLO 2nd series	All Models	>81<94	A I *
MA0-1839	163,00	A	POLO 3rd series	1.6 16v. - GTI	>95<00	A S * R
U.S.L. MA0-1840	113,00	A		1.6 16v. - GTI	>95<00	A I *
U.S.L. MA0-1877	157,00	A	POLO 4th series	1.4	>10/01	A I CrMo
VOLVO						
MA0-1600	155,00	A	240 - 242 - 244	Turbo		A S * R
MA0-1730	161,00	A	850	2.0 20v - Turbo 20v		A S *
U.S.L. MA0-1899	187,00	A	V50	1.6 TD	>02/04	A S * R

A = Front - P = Rear - S = Upper - I = Lower - * = Steel - # = Aluminium - R = Adjustable - Z = Reinforced engine compartment
U.S.L.. = available until stock last

OMP OTHER GROUPS

Descriptive List

R	Ref	Euro	Description	Colour
KARTING ACCESSORIES				
	KK0-3201-A01	75,00	C KS Cover: Waterproof kart cover. Modern K-STYLE design.	Black (KK0-3201-A01-071)
	KK0-3300-A01	45,00	C Tyre bag (suitable for 4 tyres), made in polyamide nylon, tear resistant waterproof fabric.	Black (KK0-3300-A01-071)
RACING NETS				
	NA0-1877	299,00	C Professional top level racing net FIA homologated with quick release, quick front strap adjustment to fit with several seat positions, large triangle to allow an easier mounting complying FIA rules and thinner straps to improve driver's field of view. Designed to be mounted on the left or on the right side of the driver.	
	NA0-1875	239,00	C Professional racing net FIA homologated with small-sized quick release to improve driver's field of view and front strap adjustment to fit with several seat positions. Designed to be mounted on the left or on the right side of the driver.	
	NA0-1876	115,00	C Professional entry level racing net FIA homologated with quick release and quick front strap adjustment to fit with several seat positions. Designed to be mounted on the left or on the right side of the driver.	
RACING ACCESSORIES				
	NA0-1880041	329,00	D Foldable screen to ensure safety operations privacy. It can be deployed in few seconds, four handles to hold it in position. Structure in fiberglass rib with aluminium joints, screen in airproof and waterproof nylon fabric (not fire retardant). Compact bag for transport included. SIZE (deployed): 1,8mt x 1,8mt SIZE (stored in bag): 1,4mt x 0,13mt WEIGHT: 1,9kg	Blue (NA0-1880041)
N	NA0-1884	129,00	C Heat protection car cover: Heat protection car cover that keep the cockpit cooler when the car is on the grid during summer and in hot places. The sides of the car cover can be lifted and locked in position, to permit the opening of the car door. Hook and loop to keep the side of the car cover on the door, when in closed position. Available in silver color to reflect sunlight	
	NA0-1870	107,00	C Window safety net in nylon ribbon with 60x60 mm webbing and velcro attachment. Colours: red (upon request), black. Dimensions: 50x70 cm. Meets current FIA rules.	Red (NA0-1870-061) Black (NA0-1870-071)
	NA0-1864	86,00	C Rally helmet box velvet, with wide side pockets.	Black (NA0-1864-071)
	NA0-1821	73,00	C Combination cross wheel spanner and spare wheel support. Particularly useful for Rally cars. Made of steel with durable powder coated finish.	Black (NA0-1821)
	NBO-1872	64,00	C Sleeves in aluminized fabric. One size.	Silver (NBO-1872)
	NA0-1858	63,00	C Polyester helmet carrying net. Suitable for all car and is able to hold 2 helmets.	Grey/black (NA0-1858)
	NA0-1819	54,00	C Spare wheel support with quick release system (does not require securing nut to be completely un-threaded).	
	NA0-1820	52,50	C Wheel spanner holder. Steel with rust inhibiting zinc plating.	Black (NA0-1820)
	NA0-1871	43,50	C Helmet hook in steel, to be attached to the roll cage with supplied metal clamps.	
	NA0-1822	42,00	C Spare wheel nylon tie down strap, comes complete with 3 plates and 3 fixing eye bolts.	
	NA0-1863	42,00	C Co-driver's pad (size A4). Spiral binding, 130 pages.	
	NBO-1894	30,00	C Apron Plus: Professional apron for mechanics.	Black (NBO-1894-071)
	NA0-1859	27,50	C Tank tape, 50 mm wide, highest adhesion. 50 m roll.	Black (NA0-1859-071) Grey (NA0-1859-081)
	NA0-1700-A02	24,50	C Pair of splash guards in polyethylene. Dimensions: 50x30 cm. Thickness: 1,5 mm.	Red (NA0-1700-A02-061)
	NA0-1700-A01	22,50	C Pair of splash guards in polyethylene. Dimensions: 50x30 cm. Thickness: 1,5 mm.	White (NA0-1700-A01-020) Blue (NA0-1700-A01-041) Black (NA0-1700-A01-071)
	NA0-1862	20,50	C OMP co-driver's pad. Spiral binding, 130 pages. 17,3x22.	
	NA0-1564	5,40	C Pair of ear plugs.	Yellow
PIT BOARDS				
	NC0-1067	121,00	C TRIPLA: 3 row aluminium frame pit board (72x72 cm). Complete with 24 cards of numbers, letters and symbols measuring 23 x 14 cm.	
	NC0-1068	148,00	C PROFESSIONAL 4: 4 row aluminium frame pit board (100 x72 cm). Complete with 42 cards of numbers, letters and symbols measuring 23 x 14 cm supplied in a synthetic leather which stores tidily on the aluminium frame when not being used.	
	NC0-1069	71,00	C 42 spare cards for pit boards KC/1067 and KC/1068, supplied in a synthetic leather carrying pouch.	
MASTER SWITCHES				

R	Ref	Euro	Description	Colour
	EA0-0467	16,50	C Push-button switches for exterior use, water resistant, with threaded fixing nut, 2 poles.	
	EA0-0464	10,50	C Spare key for EA/462 model.	
	EA0-0463	8,50	C Spare key for EA/460 model.	
TYRE WARMERS (PRICES EACH)				
	T00-0200-A02	1.525,00	C Electrical thermostatic control box with digital display control for tyre warming blankets. For 4 wheels.	
	T00-0200-A01	971,00	C Electrical thermostatic control box with digital display control for tyre warming blankets. For 2 wheels.	
	T00-2363-A02	682,00	C Tyre warmers for tyres ranging in size from: 230/260 mm in width, 630/645 mm diameter. Models with a central electronic temperature control box.	
	T00-1963-A02	682,00	C Tyre warmers for tyres ranging in size from: 190/220 mm in width, 630/640 mm diameter. Models with a central electronic temperature control box.	
	T00-2360-A02	682,00	C Tyre warmers for tyres ranging in size from: 230/260 mm in width, 600/620 mm diameter. Models with a central electronic temperature control box.	
	T00-1957-A02	655,00	C Tyre warmers for tyres ranging in size from: 190/220 mm in width, 570/585 mm diameter. Models with a central electronic temperature control box.	
	T00-1963-A01	611,00	C Tyre warmers for tyres ranging in size from: 190/220 mm in width, 630/640 mm diameter. Models with a standard temperature control thermostat.	
	T00-2360-A01	611,00	C Tyre warmers for tyres ranging in size from: 230/260 mm in width, 600/620 mm diameter. Models with a standard temperature control thermostat.	
	T00-2363-A01	611,00	C Tyre warmers for tyres ranging in size from: 230/260 mm in width, 630/645 mm diameter. Models with a standard temperature control thermostat.	
	T00-1957-A01	584,00	C Tyre warmers for tyres ranging in size from: 190/220 mm in width, 570/585 mm diameter. Models with a standard temperature control thermostat.	
STOPWATCHES				
	NC0-1040	43,00	C Handheld stopwatch model with liquid crystals. Chronograph with split, total elapsed times up to 9h, 59', 59.99" lap times up to 8. Clock with hours, minutes, seconds, alarm clock with 12/ 24h option. Timer with pre-settable countdown timer. 60 lap memory and lap counter. Shows fastest lap, slowest lap and average lap times.	
	NC0-1041	23,50	C Handheld stopwatch, different functions: Chronograph with partial and total elapsed times up to 9h59' 59.99", lap times. Clock with alarm clock and Pacer datar. Timer with countdown function.	
BONNET PINS				
	EB0-0480	38,00	C M10 stainless steel pins in aluminium. Extremely light with small sliding pins in stainless steel.	
	EB0-0487	37,00	C Leather straps.	Black (EB0-0487-071)
	EB0-0490	34,00	C M10 pin slide in stainless steel with large cast aluminium washers.	
	EB0-0489	33,50	C M10 stainless steel pins with large slide pins.	
	EB0-0491	31,00	C Fully stainless steel spring clips. Suitable for hatchbacks.	
	EB0-0492	25,00	C Aluminium quick release bonnet pins with stainless steel hardware.	Blue (EB0-0492-041) Red (EB0-0492-061) Silver (EB0-0492-003) Black (EB0-0492-071)
	EB0-0483	24,50	C Rubber hooks (large).	
	EB0-0482	16,50	C Rubber hooks (small).	
RACING PEDALSETS AND FOOTRESTS				
	OA0-2060	69,00	A Co-driver's footrest, knurled aluminium. Dimensions: 335 x 300 mm.	Knurled aluminium (OA0-2060)
	OA0-1866	49,00	A Co-driver's footrest in sandblasted aluminium. Complete with fixing screws, brackets and nuts. Dimensions: 320x280 mm	Sandblasted aluminium (OA0-1866)
	OA0-2080	35,00	A Universal flat footrest, knurled aluminium. Dimensions: 365 x 418 mm.	Knurled aluminium (OA0-2080)
	OA0-1010	32,50	A Complete set of 3 pedals in sandblasted aluminium with long accelerator pedal, supplied with fixing screws and nuts.	Sandblasted aluminium (OA0-1010)
	OA0-2070	29,00	A Driver's left footrest, made from knurled anodised aluminium. Dimensions: 285 x 120 mm.	Knurled aluminium (OA0-2070)
	OA0-1000	29,00	A Complete set of 3 pedals in sandblasted aluminium with standard foot accelerator pedal, supplied with fixing screws and nuts.	Sandblasted aluminium (OA0-1000)
	OA0-1867	28,00	A Driver's left footrest in sandblasted aluminium, complete with fixing screws and nuts. Dimensions: 260 x 100 mm.	Sandblasted aluminium (OA0-1867)
	OA0-1020	25,00	A Complete set of 3 pedals in sandblasted aluminium with long accelerator pedal, supplied with fixing screws and nuts.	Sandblasted aluminium (OA0-1020)
	OA0-1030	19,50	A Pre-curved aluminium pedals suitable for rally use. Already drilled and countersunk, and can be shaped as needed. Complete with screws and nuts. 3mm thick.	Silver (OA-1030)
	OA0-1050	19,00	A Pre-curved aluminium pedals suitable for rally use. Already drilled and countersunk, and can be shaped as needed. Complete with screws and nuts. 3mm thick. Thickness: 2.5mm.	Knurled aluminium (OA0-1050)
	OA0-1863	18,00	A Set of 3 pedals in sandblasted aluminium with standard accelerator pedal, supplied with fixing screws and nuts.	Aluminium (OA0-1863)
TUNING PEDALSETS AND FOOTRESTS				
	OA0-1040	35,00	A Set of 3 pedals made from anodised aluminium plate 5 mm thickness, countersunk with anti-skid insert. Complete with screws, washers and nuts.	Silver (OA0-1040-003)

R	Ref	Euro	Description	Colour
	OAO-1072	28,00	A 2 pedal set (long, floor hinged accelerator pedal and brake pedal suitable for automatic transmission) in anodized aluminium and sandblasted die-cast aluminium with anti-slip design. Complete with steel mounting hardware.	Silver (OAO-1072-003) Black (OAO-1072-071)
CO-DRIVER' MAP LIGHTS				
	6400001	51,00	Z Maplight with high efficiency LED and flex metal boom. Fixing bracket with switch. 1 Powerposition- boom lenght 50cm	
	6400002	51,00	Z Maplight with high efficiency LED and flex metal boom. Fixing bracket with switch. 1 Powerposition- boom lenght 40cm	
	6400003	51,00	Z Maplight with high efficiency LED and flex metal boom. Fixing bracket with switch. 1 Powerposition- boom lenght 30cm	
CHEMICAL PRODUCTS				
	PCO-2001	18,00	A FIRE PAINT: Special paint for exhaust systems, brake calipers, engine etc. It withstands high temperature and allow personalization of these parts. The bottle has a self-cleaning valve. Contents: 400 ml.	Red (PCO-2001-061) Blue (PCO-2001-041) Yellow (PCO-2001-051) Black (PCO-2001-071) Silver (PCO-2001-003) Gold (PCO-2001-002)
	PCO-2002	17,00	A BLACK LIGHT: Special acrylic paint in black colour, transparent, for car lights. Contents: 400ml.	Blue (PCO-2002-041) Black (PCO-2002-071)
	PCO-1001	15,00	A FINE WHEELS: Concentrated detergent for wheels and brake calipers, especially developed for cleaning the wheels both in steel or light alloy. It easily removes black marks left by brake pads. 750ml bottle.	
	PCO-2006	12,30	P The expertise of two historic companies in motorsport and care respectively, mixed together for an exclusive range of products for the cleaning and maintenance of your racing gear: OMP Motorsport Care powered by MaFra. SUEDE leather cleaner (spray 500 ml) - Cleans and hydrates the suede leather of boots and steering wheels covers. - New formula with aloe vera and natural waxes - Revives the suede and keeps it soft - Easy and fast to use	
	PCO-2005	9,80	P The expertise of two historic companies in motorsport and care respectively, mixed together for an exclusive range of products for the cleaning and maintenance of your racing gear: OMP Motorsport Care powered by MaFra. MULTIPURPOSE pre-wash degreaser and stain remover (spray 500 ml) - High performance specific pre-wash treat for grease and oil stains - Helps to blast out grease and dirt from every fabric (fire retardant or karting suits, seats, steering wheels...) - Ultra fast action - Special formula with balanced ph	
	PCO-2007	9,40	P The expertise of two historic companies in motorsport and care respectively, mixed together for an exclusive range of products for the cleaning and maintenance of your racing gear: OMP Motorsport Care powered by MaFra. Seat FABRIC cleaner (spray 500 ml) - Wipes off grease and dirt from your racing seats' fabric upholstery. - Active foam eases the removal of dirt from the fibers - Revives the fabric after the most stressing racing sessions - Easy and fast to use	
MANOMETERS				
	NC0-0081	89,00	A Manometer analog. Scale 0-40 psi, 0-2.5 BAR, 9 cm diameter with protective rubber casing. S.M.I. tested UNI-EN 837-1 norm.	
	NC0-0072	45,00	A Digital manometer with 0.05 BAR resolution, +/- 1% accuracy, 50 mm diameter, complete with 300 mm rubber hose, push button bleed off valve & protected by a shock resistant finned rubber housing. S.M.I. tested UNI-EN 837-1 norm.	
TOW HOOKS				
	EBO-0572	46,00	A Aluminium tow hook. Thickness: 6mm.	Yellow
	EBO-0580	28,00	A 2" strap tow hook in resistance red fabric with elastich chassis fixing. Meets FIA approved.	Red (EBO-0580-061)
	EBO-0576	25,00	A Tow hook stainless steel tow hook with durable bright yellow painted finish. M 12 stud complete locking nut and washers. Internal diameter: 80mm. Thickness: 8mm. Meets FIA approved.	Yellow
	EBO-0571	23,50	A Tow hook stainless steel tow hook with durable bright yellow painted finish. M 12 stud complete locking nut and washers. Internal diameter: 50mm. Thickness: 6mm. Meets current FIA rules.	Yellow
	EBO-0578	19,50	A Strap tow hook .Ring: 14 mm. Chassis fixing: 8 mm and 14 mm. Meets FIA approved.	Red (EBO-0578-061)
STAY-BARS				
	EBO-0570	33,00	A Pairs of zinc plated steel stay-bars for spotlights with variable length: min.130 mm, max.195 mm.	
LUGGAGE				

R	Ref	Euro		Description	Colour
N	OBO-2983	150,00	P	Large Trolley - Lightweight and durable fabric - Double closure with padlock-ready zipper - Resistant cargo wheels - Double handle on front and practical upper handle - Multiple internal storage compartments - Removable padded divider to store helmet or anything else - Rigid bottom with standing support - Coverable air net insert - Racing suit-inspired design insert Dimensions: 42 x 36 x 92 cm Capacity: 145LT	
N	OBO-2982	130,00	P	Medium Trolley - Lightweight and durable fabric - Double closure with padlock-ready zipper - Resistant cargo wheels - Double handle on front and practical upper handle - Multiple internal storage compartments - Removable padded divider to store helmet or anything else - Rigid bottom with standing support - Coverable air net insert - Racing suit-inspired design insert Dimensions: 38 x 33 x 70 cm Capacity: 86LT	
N	OBO-2981	105,00	P	Small Trolley - Lightweight and durable fabric - Double closure with padlock-ready zipper - Resistant cargo wheels - Double handle on front and practical upper handle - Multiple internal storage compartment and pockets - Rigid bottom with standing support - Coverable air net insert - Expansion system to gain more capacity - Racing suit-inspired design insert Dimensions: 36 x 25 x 56 cm Capacity: 22LT / 32 LT expanded	
N	OBO-2979	80,00	P	Backpack - Lightweight and durable fabric - Double closure with padlock-ready zipper - Padded notebook compartment - Upper handle - Multiple internal storage pockets - Upper quick access pocket for documents - Side water bottle pocket - Comfortable shaped shoulder straps - Racing suit-inspired design insert Dimensions: 32 x 24 x 50 cm Capacity: 20LT	
N	OBO-2980	60,00	P	CO-Driver Plus Bag Lightweight sporty bag with shoulder strap and organizational features included plenty of internal and external accessory pockets. Ideal for co-drivers. Color: Black Dimension: 40 x 34 x 20 cm	
N	OBO-2978	60,00	P	Helmet Bag Helmet bage featured by protective lining, zipped side pockets and special integrated strap to attached to a trolley bag handle for easy transport. Color: Black Dimensions: 38 x 29 x 27 cm	
'OMP STYLE' PROMOTIONAL ITEMS					
	PRO-0922	242,00	P	Paddock stool with height adjustment, footstool, customized fluo yellow spring.	
	X00-963	89,00	P	Seat support, made from painted steel, it has two different types of drilling allowing direct fitting of the seats to lower attachments or by means of side brackets.	
	X00-867	66,00	P	Flag with OMP logo. Dimensions: 1000x1500 mm.	
	X00-963-CINT	66,00	P	Safety harnesses fasten structure to be matched with the seat support X/963.	
	PRO-0936	50,00	P	Power bank with OMP light up logo. USB type-C port, 4000mAh.	
N	PRO-0940	25,00	P	OMP Umbrella: OMP windproof umbrella in polyester fabric with quick opening. 130cm diameter.	Black
	PRO-0937	24,00	P	Microfiber towel 42x90 cm	
	PRO-0938	24,00	P	Aluminium water bottle with snap hook. 800 ml	Yellow (PRO-0938-051)
N	PRO-0941	22,00	P	OMP Foldable Umbrella: OMP foldable windproof umbrella in recycled polyester fabric with quick opening. 105cm diameter.	Black
	X00-694E-15	12,60	P	Nylon band with OMP logo. Height: 15 cm. Roll 500 m= 7 kg. SOLD PER KG. RACING DESIGN.	
	PRO-0908	11,80	P	OMP pen with pen holder.	Black/silver
N	X00-693-SUIT	10,00	P	Suit bag	
N	X00-690-R01	9,00	P	Racing shoes sack	
N	X00-690-K01	9,00	P	Karting shoes sack	
	PRO-0934	7,80	P	Silicon rubber 3D OMP logo keychain	

R	Ref	Euro	Description	Colour
	PRO-0918-A01	6,60	P OMP Cap: Lightweight cotton OMP cap, velcro back closure. "Racing Spirit" design.	White (PRO-0918-A01-020) Black (PRO-0918-A01-071)
	PRO-0918-AK1	6,60	P OMPChildren Cap: Lightweight cotton OMP cap, velcro back closure. "Racing Spirit" design. CHILDREN SIZE.	White (PRO-0918-AK1-020) Black (PRO-0918-AK1-071)
N	X00-693-UND-TP	6,00	P Underwear bag (top or pants)	
N	X00-693-UND-BL	5,50	P Underwear bag (balaclava)	
N	X00-693-GLV	5,50	P Gloves bag	
	PRO-0880	4,60	P Adjustable length OMP lanyard with spring loaded clip.	
	X00-846	3,90	P Assorted sticker sheet with: tow hooks, extinguisher and master switch stickers.	
	X00-694E-80TNT	3,60	P TNT band for marking off, with OMP Logo. Height : 80 cm. SOLD PER METER. RACING DESIGN.	
	X00-889	2,80	P OMP set of 9 adhesive, several measures.	
	PRO-0935	2,60	P Silicon bracelet	
	PRO-0939		Black barrell with soft removable upper. Suitable to seat and store parts, ideal for your garage	
SIM COCKPITS				
N	ERO-0001	1.105,00	D GTR Cockpit [HTE-R] The OMP e-racing GTR cockpit is built around the renowned OMP seats. These FIA-homologated seats used in real racing enable to replicate the ergonomics of GT, Touring and Rally cars.	
N	ERO-0003	983,00	D Formula Cockpit: The OMP e-racing custom Formula seat is ideal for sim racers focused con single-seater cars. It has been succesfully tested by many globally renowned drivers and features a dedicated OMP colour scheme	
N	ERO-0002	900,00	D GTR Cockpit [CHAMP-R] The OMP e-racing GTR cockpit is built around the renowned OMP seats. These FIA-homologated seats used in real racing enable to replicate the ergonomics of GT, Touring and Rally cars.	
CUSTOM TEAMWEAR				
	ORO-5943		Short sleeved polyester polo shirt. Totally printable; comfortable and breathable. Hygienic thanks to antibacterial treatment, regular fit. Available in XXS to XXL sizes for adults (OR5923) and two sizes for children (8/10 y.o. and 10/12 y.o.) (OR5923B)	
	ORO-5942		Crew neck polyester t-shirt. Totally printable; comfortable and breathable. Hygienic thanks to antibacterial treatment, regular fit. Available in XXS to XXL sizes for adults (OR5924) and two sizes for children (8/10 y.o. and 10/12 y.o.) (OR5924B)	
	ORO-5944		Totally printable polyester sweatshirt. Comfortable, with soft knit fabric interior. Closed with zipper in the middle, elastic wristbands and waistband for maximum confort. Two handy side pockets. Regular fit. Available in XXS to XXL sizes for adults (OR5926) and two sizes for children (8/10 y.o. and 10/12 y.o.) (OR5926B)	
	ORO-5945		Totally printable polyester softshell with removable long sleeves. Comfortable, with soft knit fabric interior. Closed with zipper in the middle. Two side pockets, one inner pocket. Regular fit. XXS to XXL sizes available (OR5927).	
	ORO-5945M		Totally printable polyester long sleeved softshell. Comfortable, with soft knit fabric interior. Closed with zipper in the middle. Two side pockets, one inner pocket. Slim fit. XXS to XXL sizes available (OR5927M).	
	ORO-5945S		Totally printable polyester sleeveless softshell. Comfortable, with soft knit fabric interior. Closed with zipper in the middle. Two side pockets, one inner pocket. Regular fit. XXS to XXL sizes available (OR5927).	
	ORO-5946		Totally printable polyester winter jacket. Comfortable, with soft pile interior, ideal for low temperature. Closed with zipper in the middle; two handy side pockets and one comfortable inner pocket. Featuring hideaway hood and adjustable wristband closing with velcro. Available in XXS to XXL sizes for adults (OR5929) and two sizes for children (8/10 y.o. and 10/12 y.o.) (OR5929B)	
	ORO-5939		Totally printable polyester summer jacket. Breathable interior inner fabric. Closed with zipper in the middle, elastic wristbands and waistband for maximum confort. Two handy side pockets. Regular fit. Available in XXS to XXL.	
OFFICIAL LICENSED PRODUCT (OMP SPEED - OMP MECCANICA - OMP WHEELS)				
	OMPS9001	64,95	P OMP Meccanica - Pro Sport Safety Shoes Upper: Elastic Fabric/Microfiber Suede Locking Lining: Sandwich mesh Toe cap: Fiberglass toe Plate: Kevlar plate Footbed: Gel Sandwiched-AB-ESD Outsole: X-LIGHT Double density PU/TPU Standard: S1P SRC ESD Laces: 2 Sets Sizes: 36-48 Colors: Black/orange	
	OMPS9002	64,95	P OMP Meccanica - Pro Urban Safety Shoes Upper: Microfiber Suede Locking/Elastic Fabric Lining: Sandwich mesh Toe cap: Composite Plate: Kevlar plate Footbed: Gel Sandwiched-AB-ESD Outsole: X-LIGHT Double density PU/TPU Standard: S3 SRC ESD Laces: 2 Sets Sizes: 37-48 Colors: Black/red, Black	

R	Ref	Euro		Description	Colour
	OMPS18010619	59,95	P	OMP Speed - Car Cover (M) Materials: 3 -layers 110g/m ² PP+PE+PP+ Spunlace cotton. Description: All Weather Car Cover, Reflective Grey Line Along Both Sides, Mirror Pocket, Rear License Plate Window, Elastic Band Both Front & Rear, Anti-Theft Grommet, 4 Wheels Tie up lace, Storage Bag. Available Sizes: M-L-XL Colour: Black with Grey Strip M: 457X165X120CM (part n. OMPS18010619) L: 488X178X120CM (part n. OMPS18010819) XL: 533X178X120CM (part n. OMPS18011019)	
	OMPS18010819	64,95	P	OMP Speed - Car Cover (L) Materials: 3 -layers 110g/m ² PP+PE+PP+ Spunlace cotton. Description: All Weather Car Cover, Reflective Grey Line Along Both Sides, Mirror Pocket, Rear License Plate Window, Elastic Band Both Front & Rear, Anti-Theft Grommet, 4 Wheels Tie up lace, Storage Bag. Available Sizes: M-L-XL Colour: Black with Grey Strip M: 457X165X120CM (part n. OMPS18010619) L: 488X178X120CM (part n. OMPS18010819) XL: 533X178X120CM (part n. OMPS18011019)	
	OMPS18011019	64,95	P	OMP Speed - Car Cover (XL) Materials: 3 -layers 110g/m ² PP+PE+PP+ Spunlace cotton. Description: All Weather Car Cover, Reflective Grey Line Along Both Sides, Mirror Pocket, Rear License Plate Window, Elastic Band Both Front & Rear, Anti-Theft Grommet, 4 Wheels Tie up lace, Storage Bag. Available Sizes: M-L-XL Colour: Black with Grey Strip M: 457X165X120CM (part n. OMPS18010619) L: 488X178X120CM (part n. OMPS18010819) XL: 533X178X120CM (part n. OMPS18011019)	
	OMPS18040713	94,95	P	OMP Speed - Sport Car Cover (Interior/ M-L) Materials: Polyester Brushed 170g/m ² with Spandex, High Elasticity. Description: Interior Cover, Elastic Band both Front and Rear, Fits 2/4 Doors Cars, Storage Bag Available Sizes: M-L/L-XL Colour: Black 450x140x120CM (part n. OMPS18040713) 505x165x120CM (part n. OMPS18040913)	
	OMPS18040913	94,95	P	OMP Speed - Sport Car Cover (Interior/ L-XL) Materials: Polyester Brushed 170g/m ² with Spandex, High Elasticity. Description: Interior Cover, Elastic Band both Front and Rear, Fits 2/4 Doors Cars, Storage Bag Available Sizes: M-L/L-XL Colour: Black 450x140x120CM (part n. OMPS18040713) 505x165x120CM (part n. OMPS18040913)	
	OMPS20002009	799,00	P	OMP Meccanica - Lithium Battery 20AH Materials: ABS Description: Lithium Battery for cars with Alternator, 20AH/256WH, PCC 1000A, Weight 3.8KG, For cars upto 4000CC.	
	OMPS20001809	699,00	P	OMP Meccanica - Lithium Battery 18AH Materials: ABS Description: Lithium Battery for cars with Alternator, 18AH/230WH, PCC 900A, Weight 3.5KG, For cars upto 2000CC	
	OMPS1911	24,95	P	OMP Meccanica - Mechanic Gloves Material: Stretch Fabric, Microfiber Description: SRB Padding, Elastic Hook and Loop, Breatheable Available Sizes: S-M-L-XL Colour: Black/Yellow	
	OMPS00011503	245,00	P	OMP Wheels - Rally Wheel White rally wheel. 15 X 6.5 4X100 35 60.1	
	OMPS00021503	245,00	P	OMP Wheels - Rally Wheel White rally wheel. 15 X 6.5 4X108 16 65.1	
OMP - AUTOMOBILI LAMBORGHINI COLLECTION					
	IA0-1860-A02	1.097,00	L	ONE-S Suit Lamborghini: Fire retardant top level overall. Developed for the highest lightness without sacrificing the comfort. Semi floating arm bellows, legs and inner collar inserts in soft knitted elastic fabric. Breathable and elastic inserts in new stretch Dry System fabric on lumbs. High breathability parts in Dry System 3D material on low back, hips, neck and under the sleeves. Regular fit, with ultraflat antirubbing seams, soft knitted inside and a comfortable hidden inner pocket. With belt to improve fitting. OMP - AUTOMOBILI LAMBORGHINI COLLECTION Sizes: 46-64 Homologation: FIA 8856-2018	Black (IA0-1860-A02-071-XX)
	IE0-0791-A02	95,00	L	ONE EVO Balaclava Lamborghini: Top level balaclava made with comfortable fire retardant seamless fabric that ensures the best comfort. Two later seams on top for the best fitting. 3D Dry System Technology. Two sizes available. OMP - AUTOMOBILI LAMBORGHINI COLLECTION Sizes: S/M - L/XL Homologation: FIA 8856-2018	Black (IE0-0791-A02-071-XX)
	IE0-0792-A02	206,00	L	ONE EVO Top Lamborghini: Top level long sleeved underwear top with high neck for maximum protection made with a comfortable fire retardant seamless fabric. The high breathability fabric inserts "3D cube" on main perspiration areas ensures the best comfort and a perfect fitting (3D Dry System Technology). OMP - AUTOMOBILI LAMBORGHINI COLLECTION Sizes: XS/S (42-46), M (48-50), L (52-54), XL/XXL (56-58) + XXXL (60-64) upon request Homologation: FIA 8856-2018	Black (IE0-0792-A02-071-XX)

R	Ref	Euro	Description	Colour
	IEO-0793-A02	158,00	L ONE EVO Pants Lamborghini: Top level underwear pants made with a comfortable fire retardant seamless fabric. The high breathability fabric inserts "3D cube" on main perspiration areas ensures the best comfort and a perfect fitting (3D Dry System Technology). OMP - AUTOMOBILI LAMBORGHINI COLLECTION Sizes: XS/S (42-46), M (48-50), L (52-54), XL/XXL (56-58) + XXXL (60-64) upon request Homologation: FIA 8856-2018	Black (IEO-0793-A02-071-XX)
	IEO-0766-A02	46,00	L ONE Socks Lamborghini: Technical socks made with advanced knitting techniques to provide differentiated pressure areas, with beneficial effect on blood circulation, reducing the feeling of fatigue on the legs while driving. OMP - AUTOMOBILI LAMBORGHINI COLLECTION Sizes: S - M - L Homologation: FIA 8856-2018	Black (IEO-0766-A02-071-XX)
	IBO-0747-A02	46,00	L Tazio: Driving glove with vintage design, made with smooth leather and fishnet fabric. -Sizes: S-XL	Black (IBO-0747-A02-071-XX)
	ICO-0784-B02	304,00	L CARRERA Low Boots: Mid cut vintage design boot made of high quality treated leather for an ultrasoft feel. Contrasting inserts, laced closure, with a handcrafted rubber sole hydrocarbons resistant. -Sizes 37-48. -Homologation: FIA 8856-2018	Black (ICO-0784-B02-071-XX)
	NBO-1580-B02	152,00	L BLAST EVO : Professional mechanics suit made of lightweight and resistant polyester and cotton fabrics. The knitted elastic fabric inserts on back and hips and the comfortable arm-bellows guarantee the best freedom of movements. Several practical pockets to store tools and parts: two large-sized on the legs, two with zip closure (one on the right leg and one on the chest) and an inner one on the chest. Removable high resistant padded knee pads. Elastic wrist closure and ankles with velcro strap to improve fitting. Aggressive design with racing-inspired shoulders and highlighted stitching. Sizes: 44÷64	Black (NBO-1580-B02-071-XX)



2024 RETAIL PRICE LIST
AND APPLICATION LIST

RACING**FORCE**GROUP

